

Smart choice for power

xantrex



Save
more
than
time

Our new Xantrex GT 3.0 Grid Tie Solar Inverter costs less per watt and is easier to install than any other grid tie inverter on the market.

When Xantrex set out to develop our new grid tie inverter, we listened to the experts – renewable energy dealers and installers. The result is a high performance three-kilowatt string inverter that offers superior PV energy harvest, easy installation, state-of-the-art design and high reliability. And with an MSRP of only \$2500 for 3000 watts of power, our GT 3.0 also offers the best price/performance in the industry.

For details on our breakthrough inverter, visit www.xantrex.com/gridtie. Or call 1-800-234-6431 and we'll send you our new brochure.

Xantrex GT 3.0 Grid Tie Solar Inverter

- ▶ CEC listed
- ▶ Breakthrough price/performance
- ▶ Superior PV energy harvest
- ▶ All-in-one three kilowatt system design
- ▶ Lightweight, easy to install

www.xantrex.com

SMA America's Solar Family...

Something to Smile About

SMA America has long been a leader in solar technology, with a growing family of products. From our Sunny Boy 700U to the Sunny Island 4248U, we specialize in the most powerful, efficient, reliable and flexible photovoltaic inverters on the market today.

That's because our philosophy is, quite simply, understand what our customers want, and provide it. So we work hard to meet your family's needs, whether residential or commercial, on-grid or off-grid.

Our dealers and installers are also a part of our family, trained as SMA Solar Pros to design and implement Sunny Boy solar electric power systems. Call us to find the Solar Pro nearest you.

We're especially proud of the newest SMA family member, the Sunny Island 4248U. This commercial-grade inverter works seamlessly with existing systems, and can be used for either off-grid needs or as backup to grid-tied systems, using smart technology to deliver peak efficiency and dependability.

SMA America: the best in solar technology. From our family... to yours.





SMA America:
Here we grow again!

Sunny Island 4248U

Perfect for off-grid energy, or as backup power to on-grid systems!

SMA America, Inc.
12438 Loma Rica Drive
Grass Valley, CA 95945
Tel. 1.530.273.4895
Email: info@sma-america.com
Web: www.sma-america.com

SMA America is pleased to introduce the newest addition to our product line: the Sunny Island 4248U.

The Sunny Island 4248U is a 4200 Watt commercial grade inverter that's ideal for off-grid systems, or as backup power for on-grid systems. It is the result of years of dedicated research and development, and the finest in solar technology – and it shows.

Built for flexibility, the Sunny Island 4248U can be incorporated into current systems, or used on its own. Rely on it to generate power off-grid practically anywhere... or depend on it as backup to on-grid systems when power is lost. And, it does it all at 95% peak efficiency – among the best in the industry.

The Sunny Island 4248U: the future of solar technology is here.

Solar Today...
Energy Tomorrow



Plenty of PV Modules. Wind & Hydro Systems. All Balance-of-System Items.

AEE Solar Has It All!

The only one-stop, full-service wholesale distributor you'll ever need!

25-YEARS
of dealer
satisfaction!

Featured this Month



Small PV Modules

Our new proprietary line of 5-, 10-, 20- and 50-watt modules for remote power, telecom and water pumping applications.



AEE
Exclusive!

Digital Volt and Amp Meters

Perfect for monitoring 12-, 24- and 48-volt battery systems.

NEW!

AEE
Exclusive!



Custom-Configured Power Panels

Power panels with Outback, Xantrex or SMA inverters for grid-connected and stand-alone applications.



Grundfos SQFlex Pumps

Solar-powered deep-well pumps deliver 25,000 gallons per day at 25 feet. Can pump from depths up to 500 feet.



Order Online at www.aeesolar.com

Call us for a password and quick demo!

We offer dealers and installers:

- Competitive prices on all the top brands
- Unsurpassed technical expertise
- Widest selection in the business including all items for NEC-compliant installations

2005 AEE Catalog Now Available –

with space for your
name and logo!

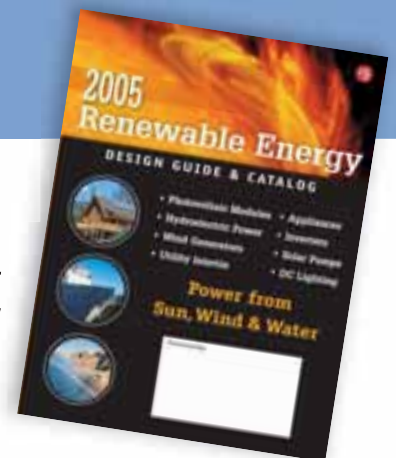

AEE Solar
SUPERSOURCE
Bringing Power to the People Since 1979

formerly Alternative Energy Engineering



800-777-6609

8:30 - 5:00 Pacific Time, Monday - Friday

www.aeesolar.com

1155 Redway Drive • PO Box 339, Redway, CA 95560
707-923-2277 tel • 707-923-3009 fax • info@aeesolar.com

RECYCLED POWER



At U.S. Battery, we're committed to doing our part in keeping the environment clean and green for future generations, as well as providing you with premium deep cycle products guaranteed to deliver your power requirements when you need them.



**DON'T SETTLE
FOR ANYTHING LESS
THAN U.S. BATTERY
PRODUCTS!**

Kyocera Empowers Your Future



- Power Range 35-187 watts
- NEW +10% -5% Power Tolerance
- Class 1 Div 2 for KC35-KC120
- UL Listed
- Building Quality Modules Since 1975
- Now Manufactured in North America
- Visit Our Newly Upgraded Website!

The Power of Choice

From our comprehensive family of modules to our 25 year warranty, Kyocera Solar takes a pro-active approach to anticipating the needs of our customers. Call 800-223-9580 or click www.kyocerasolar.com to learn more.

THE NEW VALUE FRONTIER

 **KYOCERA**
KYOCERA Solar, Inc.



ReadyWatt Makes Power Independence and Clean Energy as Easy as 1-2-3

Your ReadyWatt™ Dealer can help you decide which system will best meet your needs



Your ETL® listed system includes the PV Powered® StarInverter™, the highest efficiency inverter available today, with a ten year warranty. Made in the USA.

Both the built in meter and free Windows® based software continuously monitor and display your system's power production and calculate how much CO₂ is being kept from the Earth's atmosphere.



	1	2	3
ReadyWatt™ System	GT 900	GT 1800	GT 2800
Estimated Annual Output			
Based on 4.5 hours of sun a day.	1,000 kWh	2,000 kWh	3,500 kWh

Each system comes complete with all the components you need

Equipment			
PV Module	Isofotón 150	Isofotón 150	Isofotón 150
Module Quantity	6	12	21
Roof Mounts	(2) 3-module	(4) 3-module	(7) 3-module
PV Junction Box	1	1	1 (fused)
MC Cables	(1) 50'	(2) 50'	(2) 50' & (1) 100'
PV Grounding	Lay In clamps	Lay In clamps	Lay In clamps
Grounding Wire	30'	60'	120'
ReadyWatt GT Power Center			
Inverter	PVP1800	PVP1800	PVP2800
AC Grid Disconnect	GE 30A 240VAC	GE 30A 240VAC	Square D 30A 240VAC
Dimensions h/w/d	30" x 52" x 8"	30" x 52" x 8"	30" x 52" x 9"
Weight	100 lbs	100 lbs	125 lbs
Specifications and Ratings			
Array Size In Sq. Ft.	82.7	165.5	289.6
DC Watts - STC	900	1800	3150
Warranty			
ReadyWatt & System Equipment	10 year	10 year	10 year
Isofotón Power output	25 year	25 year	25 year

Your ReadyWatt™ Solar Electric System also features:

- Isofotón 150 Watt, UL® listed, high efficiency solar modules for your home
- 25 year power output warranty



Isofotón® is the sixth largest photovoltaic module manufacturer in the world. With over 23 years experience, they are the number one PV provider in Europe and are now in the USA.

Call Today for a ReadyWatt™ Dealer Near You! **800 GO SOLAR**



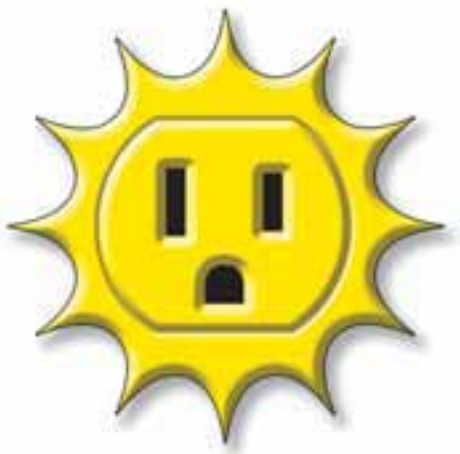

HP106

contents



12 **offshore** solar

John McNicholas

The McVicker family's luxury vacation home off the Florida coast is powered by solar electricity—the best choice for form and function.

22 **farming** the wind

Randy Brooks

June and Charlie Nichols loved their first wind generator so much, they installed a second one. Now they're selling twice as much energy to their utility.

26 **gear:** inverters

Joe Schwartz

Inverters, a main component of renewable energy systems, have come a long way. Eight high-tech, grid-tie models are showcased.

36 **building** efficiency

Patrick Sughrue

Save time, energy, and money—structural insulated panels (SIPs) make energy-efficient construction of walls and roofs quick and easy.

44 **choosing** solar

Linda Pinkham

Important design variables to consider before you invest in a solar-electric system.



On the Cover

Solar-powered luxury—the McVickers' vacation home has all the comforts of the mainland, but on a Gulf Coast barrier island.



52 **ram** pump

Gwen Holdmann

Learn how water can pump itself with the magic of a hydraulic ram pump.

60 **solar** fountains

Hal Aronson & Tor Allen

Schoolkids built one—so can you. Step-by-step instructions for making your own solar fountain in just a weekend.

68 **remote** communication

Bill Layman

A portable, flexible solar-electric panel allows Bill to update his online travel journal from the wilds of Canada's canoeing paradise.

74 **efficiency** test

Allison A. Bailes III

Planning energy improvements? Blower door and Duct Blaster tests evaluate the efficiency of your home and its heating system.

82 **tank** maintenance

Chuck Marken

Whether you have a solar storage tank or a backup water heater, a little bit of anode rod attention will save a lot in the long run.

88 **driving** range

Shari Prange

Can you get there from here, on battery power?

Regulars

10 From Us to You

HP crew

Where do we stand?

92 Code Corner

John Wiles

PV checklist.

96 Independent Power Providers

Don Loweberg

Expos & education.

100 Power Politics

Michael Welch

Nuke resurgence.

104 Word Power

Ian Woofenden

Rotor.

106 Home & Heart

Kathleen

Jarschke-Schultze

Finding home.

120 Ozonal Notes

Richard Perez

Controllers & inverters.

80 Subscription Form

108 Letters

114 RE Happenings

118 Q&A

122 Readers' Marketplace

124 Installers Directory

128 Advertisers Index

Where Do We Stand?



The United States was once the leader in photovoltaic (PV) research. Today, other leaders have emerged—Japan now spends four to five times more than the United States on PV research, and Germany's funding is triple the U.S. level. To further widen the gap, the 2005 budget request to Congress actually *reduces* the funding for solar energy in the United States by 1.3 percent.

The United States used to lead the industry in worldwide PV module sales, which have doubled since 2002 to US\$5 billion in 2004. Now the U.S. market share of that global boom is a mere 10 percent. The domestic market for PV installation lags too. In 2003, Japan installed 219 megawatts (MW) of PV and Germany installed 145 MW, while the United States installed only 66 MW. Currently, solar-electric panels are downright difficult to obtain in the United States because of how hot the market is elsewhere.

Part of the problem, according to Solarbuzz.com, is that in the United States, "unlike the solar markets of Japan and Germany...there is little nationwide drive for solar energy." In the United States, nearly all pro-solar policies are created at the state level. In 2004, Germany passed a federal "feed-in law" that guarantees payments of 45.7 to 57.4 euro cents per KWH for solar-generated electricity for the next two decades. As many systems were installed in Germany in 2003 as were installed in the United States in the previous *twenty* years. With Germany's new tariff, we can expect their market to continue to grow at a healthy rate.

A Solarbuzz analysis characterizes the problem for us: "The U.S. solar market appears defined by partisan rather than bipartisan characteristics. This tends to limit solar energy to being discussed as [a] 'political' rather than 'business' or 'economic' item."

No matter how hard we try, we just can't seem to divorce politics from renewable energy. But examined in the context of business and economics, dollars and sense (and let's not forget the environment), it just doesn't seem practical for this to be a political issue. Let your local, state, and federal representatives know that you support renewable energy technologies becoming a major part of this country's business, economic, and energy future.

—Linda Pinkham for the *Home Power* crew

Think About It...

"North America has 7 percent of the world's population, but consumes 30 percent of the world's energy."

—Energy Ottawa, Green Power Fast Facts

Legal: Home Power (ISSN 1050-2416) is published bimonthly for \$22.50 per year at PO Box 520, Ashland, OR 97520. International surface subscription for US\$30. Periodicals postage paid at Ashland, OR, and at additional mailing offices. POSTMASTER send address corrections to Home Power, PO Box 520, Ashland, OR 97520.

Paper and Ink Data: Cover paper is Aero Gloss, a 100#, 10% recycled (postconsumer-waste), elemental chlorine-free paper, manufactured by Sappi Fine Paper. Interior paper is Connection Gloss, a 50#, 80% postconsumer-waste, elemental chlorine-free paper, manufactured by Madison International, an environmentally responsible mill based in Alsip, IL. Printed using low-VOC vegetable-based inks. Printed by St. Croix Press Inc., New Richmond, WI.

HP staff

- Publisher** Richard Perez
Publisher & Business Manager Karen Perez
CEO & Technical Editor Joe Schwartz
Advertising Manager Connie Said
Marketing Director Scott Russell
Customer Service & Circulation Nat Lieske
Shannon Ryan
Managing Editor Linda Pinkham
Senior Editor Ian Woofenden
Submissions Editor Michael Welch
Associate Editor Claire Anderson
Art Director Benjamin Root
Graphic Artist Dave Emrich
Chief Information Officer Rick Germany
Solar Thermal Editor Chuck Marken
Solar Thermal Technical Reviewers Ken Olson
Smitty Schmitt
Green Building Editors Rachel Connor
Laurie Stone
Johnny Weiss
Transportation Editors Mike Brown
Shari Prange
Regular Columnists Kathleen Jarschke-Schultze
Don Lowebug
Richard Perez
Michael Welch
John Wiles
Ian Woofenden

HP access

Home Power Inc.
PO Box 520, Ashland, OR 97520 USA
800-707-6585 or 541-512-0201
Fax: 541-512-0343
hp@homepower.com
letters@homepower.com

Subscriptions, Back Issues & Other Products: Shannon and Nat
subscription@homepower.com

Advertising: Connie Said
advertising@homepower.com

Marketing & Resale: Scott Russell
marketing@homepower.com

Editorial Submissions: Michael Welch
submissions@homepower.com

www.homepower.com

Copyright ©2005 Home Power Inc. All rights reserved. Contents may not be reprinted or otherwise reproduced without written permission. While *Home Power* magazine strives for clarity and accuracy, we assume no responsibility or liability for the use of this information.



Southwest Windpower
Renewable Energy Made Simple

Call for Lowest Price
in the Nation
H-40 Turbines

900W (180Kw max. @ 15 mph avg)
SCALL

H-80 Turbines
1800W (360Kw max. @ 15 mph avg)
SCALL

AIR X
12, 24, 48 Volt
Call for Lowest Price in the Nation

WHISPER
H-175 Turbines
3000W (600Kw max. @ 15 mph avg)
"The Great
Powerful Thriller
of the Lowlands"



1.800.329.3283

www.earthsolar.com • contact@earthsolar.com

EarthSolar, LLC • 6315 Canyon Dr. • Amarillo, Texas 79110 LOWEST PRICES IN THE NATION!

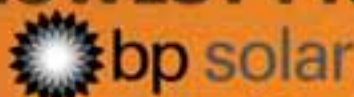

BP 3125, 125W SCALL
BP 3160, 100W SCALL

WE HAVE
SOLAR PANELS!
Please call for Panel



KC120
120 Watts
KC125G, 125Watts SCALL
KC167G, 167Watts SCALL

SHARP
175W SCALL

Pricing and Availability

UNI-SOLAR

US3, 100W US5, 100W
US5, 100W US5, 100W

OutBack
Power Systems

True Sine Wave Inverters
FX2024

CALL FOR LOW QUOTE

FX2548

CALL FOR LOW QUOTE

MX60 Charge Controller

works with all inverters to

allow with any battery

CALL FOR LOW QUOTE

MATE System

Display/Remote

compatible with

any inverter

CALL FOR LOW QUOTE

SHELL
SIEMENS

SQ80, 12V SCALL

SQ85, 12V SCALL



Kill A Watt
Call for Lowest Price
in the Nation

xantrex

SW4024 12V SCALL
SWP1012524 12V SCALL

PRICES SO LOW WE CAN'T PRINT THEM!



SUN-MAR

Excel
Compact
Excel NE

The Watch
Awarded by
Competitive
Tribunal Technology

Call for
Lowest Price
in the Nation



STABER
HXW2304
Super
Efficient
Washer



Rolls-Surrette
Solar Deep Cycle Batteries
FREE freight on Quantity Orders!
CALL FOR DETAILS

Model S-530 SCALL
Model S-460 SCALL
530 AH (100 hr rate)
460 AH (100 hr rate)
12.25" x 7.125" x 16.75"
117 lb (wet), 90 lb (dry)

GRUNDFOS
SQFlex
SCALL



Dankoff
Integrated
Systems
SCALL



DCR165 DC Refrigerator
DCF165 DC Freezer
DCR225 DC Refrigerator
DCF225 DC Freezer

Call for
Lowest Price
in the Nation

SunDanzer

NOTICE!

Services that Earth Solar provides:

If you purchase your system from Earth Solar we provide the following services absolutely free of charge:

- FREE Load Calculation & Design
- FREE Code compliant engineering
- FREE System diagrams
- FREE Phone consultations
- FREE Troubleshooting

Earth Solar provides installation nationally and internationally.

Please call us if you have a project that needs a professional touch.

Package Systems

1.5KW GridTie \$8580
panels, racking,
fusing/disconnects
and inverter

3KW GridTie \$14,760
panels, racking,
fusing/disconnects
and inverter

Residential \$32,500

- 30) 175W solar modules
- OutBack Inverters
- OutBack Charge Controller
- OutBack Disconnects
- racking
- Rolls S-460 batteries

Cabin Starter \$2898

- 2) 120W solar modules
- Trace DR Inverter
- charge controller
- disconnects
- rack
- 4) Rolls S-460 batteries

OFF SHORE & OFF GRID

Island Life Unplugged

John McNicholas

©2005 John McNicholas

Keewaydin Island is located in the Gulf of Mexico, just off the coast of southwest Florida. It is the longest unbridged barrier island left in the state, with pristine beaches that stretch for almost 8 miles (13 km). There are no full-time residents, no roads, no utilities, and access is by boat only. It is home to abundant wildlife, a shell-encrusted beach, the sound of the surf, and beautiful sunsets. Against this breathtaking natural backdrop, fifteen homes dot the landscape, ranging from extremely rustic cottages to lap-of-luxury, estate-style getaways. What they all have in common is their reliance on off-grid electrical systems.



It is here that Monica and Jack McVicker decided to build their dream beach house. They wanted a retreat from their mainland home, a place for their kids to roam and experience nature. They wanted to build in style, with a tennis court on the beach. Of course, central air conditioning is required to cool down after a match, and a hot tub on the roof eases those sore muscles. Kitchen amenities include a Viking propane range, KitchenAid refrigerator, dishwasher, garbage disposal, and microwave. And to kick back on a Sunday afternoon with a football game, a satellite TV system was installed.

“When we first saw Keewaydin Island, we knew it was for us,” said Monica and Jack. “The idea of building a self-supporting island getaway within 20 minutes of our home was an opportunity we just couldn’t believe existed. Our goal was to create a natural playground for our kids and friends, and to take advantage of the unique concepts in building a ‘green’ house, but with creature comforts. Thanks to the great team that put it all together, we couldn’t be happier with the outcome!”

I was brought in during the design phase by Barnett Design Studio. Marie Barnett has a Bachelor of Architecture degree with special emphasis on environmental design. Since moving to Florida in 1989, she has specialized in the design of unique, custom homes. Marie has designed other houses on the island, and is adept at blending the owner’s vision with the special requirements of off-grid homes.

Seaside solar electricity—twelve RWE Schott 300-watt photovoltaic modules provide most of the electricity for a full-function home in this private paradise.



Living off the grid, with style—Monica and Jack McVicker mix environmentally friendly energy sources with luxury living at their island getaway.

Marie says, “I feel that Keewaydin Island is unique and special. All of the homes that I design must work integrally with the site elements. The design of a Keewaydin Island home is very different from a house in town. The energy systems, water collection, and access to the site all become essential design elements from the initial design phase. A house that is built on the mainland would typically integrate these elements later in the design process. The self-sustaining nature of these island homes ensures that they do not interfere with the beauty and environment of Keewaydin Island. The construction of the McVicker home demonstrates that you can build a house with renewable energy systems and still have comfort!”

Continental Construction was chosen to be the general contractor and builder for the project. They were involved in construction on the north end of the island, and were already equipped with the barge necessary to move all the materials to the site. John Cecil, project manager, was excited about the challenge. “Barrier island construction is demanding and requires a lot of forethought. With the McVicker home nearly a 12-mile (19 km) round trip, you can’t just run back to the marina because a subcontractor was late or you forgot the bug spray. Working with Jack and Monica on an almost daily basis during construction proved essential. With the addition to an already well-thought-out design of



Elevated to second-story level, the McVickers' house is designed to catch cool ocean breezes. Deep roof overhangs shade the windows and help their home keep cool.

things like the widow's walk on the roof, the McVickers' retreat is one of the signature homes on the island."

Technical Design

For my role, designing a photovoltaic system to power a 2,200-square-foot (204 m²) house that has a hot tub, central air conditioning, and a boat lift was interesting indeed. In designing a system for a setting such as this, I have found that you must consider it likely that the guests will somehow find a way to use every electrical appliance at once. Forget the idea of house rules governing which appliances can be used simultaneously!

All the comforts of town at a private oceanfront retreat—quiet luxury made possible by solar electricity.



So you must provide support for maximum power draws. The catch is to make all this work within an acceptable budget. Jack understood the limitations of inverter-based systems, and was open to intelligent trade-offs in search of a balance between cost and function.

This three-bedroom, three-bath home is powered by two Xantrex 4,000-watt, 24-volt, sine wave inverters (SW4024s) serial stacked together, and a third SW4024 connected to a pair of OutBack FX2024 inverters with the new OutBack MIG2 product (see sidebar on page 18). RWE Schott (formerly ASE) 300-watt photovoltaic panels charge the batteries through Trace C40 controllers and a GFPI for ground fault protection. Two OutBack PSPV combiner boxes are mounted in a panel in the lookout landing.

To provide enough storage capacity, four HuP Solar-One, 1,270 amp-hour batteries were installed, wired in series and parallel to provide close to 50 KWH of storage at 24 VDC, at 80 percent depth of discharge (DOD), the extreme. We chose a large, propane-fueled Onan 20 KW generator for battery charging and backup purposes. This provided us with the extra capacity to handle large loads, such as supporting the central air conditioning unit plus the two inverters in charger mode at the same time.

To free the inverters from the start-up surge required by the 240-volt, 10,000-pound rated, boat-lift motors, we connected the lift to the generator and installed a remote starting switch

with a timer at the dock. The hot tub has a 6 KW heater in it, which would have used the capacity of one set of inverters, so it too was connected to the generator. When the heater is called for, the generator is automatically started. To maintain the automatic water filter cycling, we designed that portion of the tub to run from the inverters.

Because the humidity on the island is brutal during the summer months, the owners had a design requirement for air conditioning capability, even when the house is unoccupied. The thermostat circuit is powered from the inverters. We tag off the thermostat's 24-volt AC output,



A modern kitchen requires a modern power source—solar.

McVicker House Loads*

Description	Watts	Daily Run	
		Hours	KWH
Refrigerator	180	10.0	1.80
Living room loads	1,440	3.0	4.32
Master bedroom loads	1,320	2.0	2.64
Kitchen lighting	600	4.0	2.40
Bedroom #2 loads	400	2.0	0.80
Breezeway lighting	750	1.0	0.75
Living room receptacles	360	2.0	0.72
Bedroom #3 loads	400	1.0	0.40
Bedroom #4 loads	400	1.0	0.40
Garbage disposal	600	0.5	0.30
Gas range	300	1.0	0.30
Master bath	300	0.5	0.15
Guest bath #2	300	0.5	0.15
Exterior lights	600	3.0	1.80
Gas dryer	780	1.0	0.78
Clothes washer	1,440	0.5	0.72
Pressure water pump #1	1,200	0.5	0.60
Pressure water pump #2	1,200	0.5	0.60
Hot tub filtering	240	2.0	0.48
Microwave	1,320	0.3	0.40
Dishwasher	780	0.5	0.39
Kitchen receptacles, east	1,500	0.2	0.30
Kitchen receptacles, west	1,500	0.2	0.30
AC controls #1	120	1.0	0.12
AC controls #2	120	1.0	0.12
Laundry room	240	0.5	0.12
Generator shed lighting	240	0.1	0.02
Solar room loads	240	0.1	0.02
Total Daily KWH			21.90

*Worst-case scenario loads

which controls the compressor, to a contactor that remotely starts the generator. We found an efficient Trane central air conditioning unit with a two-speed compressor that starts up on slow speed. A hard-start kit was added (basically just a capacitor).

With this arrangement, we can even run the unit directly on one set of the inverters! Since the house is not regularly used during the summer months, this gave us the opportunity to dedicate the two inverters to the air conditioning unit, reducing expensive run time on the generator. A Square D, four-pole switch was installed to allow the McVickers to choose either means of support. With some testing and tweaking, a balance has been found between the humidity level in the house and the minimal use of the generator, with the 3,600 rated watts of photovoltaic panels supplying most of the energy.

Construction & Installation Details

The installation of the panels was my most challenging to date. A wooden platform was built across the forks of a forklift, which then raised us and the materials to the roof, more than three stories up. The roof is standing-seam metal, which at a roughly 30-degree pitch is exceedingly slippery, highly reflective, and just plain hot to work on. Structural aluminum angle rails 1/4-inch (6 mm) thick were used with 1/2-inch (13 mm) diameter stainless steel lag bolts into the rafters. We had our welder make a jig frame with the precise mounting holes drilled for the panels, to assist us with rail placement. Since the panels would be visible close-up from the hot tub deck, the owner requested that the long wiring runs be hidden. They were placed in conduit under the roof sheathing before the roof was closed up, making a very clean look.

The main water supply is rainwater, collected from the roof into two, 5,000-gallon (19,000 l) capacity aboveground cisterns equipped with roof washer diversion valves. Household pressure is supplied by 3/4 hp 120-volt pumps. The water flows through a carbon canister filter and then a UV filter. A shallow well was dug as a backup. A standard, propane, 40-gallon (150 l) water heater supplies hot water for domestic use.

Construction of the house took one year, since the remote location and transportation time slows progress on the island. Mother Nature always has her say too. We had to contend with some wild boars on this project, who appeared to take our presence personally. A charging boar with sharp tusks is not a pretty sight! Also, since Keewaydin Island is a barrier beach, it is a refuge for loggerhead sea turtle nesting. Special consideration had to be given to the timing and usage of large equipment. With concern for keeping any nature disturbance to a minimum, special exterior lights were chosen and approved by the Florida Department of Environmental Protection to avoid drawing hatchlings toward the house.

Off-Grid Luxury

Jack enjoys showing guests his renewable energy system. They are usually amazed that such a home can be powered in this fashion. Their interest is heightened when he mentions that the family moved to the beach house temporarily after Hurricane Charley interrupted utility service on the mainland, living there comfortably until the grid was restored after four days.

Although intended to be a weekend getaway, the more intense use of the house as a possible backup dwelling during hurricane season has made the design goal of keeping generator run time to a minimum all the more important. To deliver propane, a 2,500-gallon (9,500 l) propane truck is loaded onto a barge for topping off the



Tech Specs

System Overview

System type: Off-grid battery-based PV system

Location: Keewaydin Island, Florida

Solar resource: 5.5 average daily peak sun hours

Production: 400 AC KWH average per month

Photovoltaics

Modules: 12 RWE Schott, ASE 300-DGF/17, 300 W STC, 17.0 Vmp, 12 VDC nominal

Array: Six, two-module series strings, 3,600 W STC total, 34 Vmp, 24 VDC nominal

Array combiner box: Two OutBack PSPV, 30 A breakers

Array disconnects: 60 A breakers in DC250 and PSDC-175 enclosures

Array installation: Custom aluminum rails, SSW orientation, 30-degree tilt

Energy Storage

Batteries: Four HuP Solar-One, SO-6-85-25, 12 VDC nominal, 1,270 AH at 20-hour rate, flooded lead-acid

Battery pack: 24 VDC nominal, 2,540 AH total, 48.8 KWH total at 80% DOD

Battery/inverter disconnects: Xantrex DC250, two 250 A breakers; OutBack PSDC-175, two 175 A breakers and one 250 A breaker

Balance of System

Charge controllers: Three Xantrex C40s, 40 A, PWM

Inverters: Two Xantrex SW4024, 4,000 W each, 8,000 W total, 24 VDC nominal input, series stacked for 120/240 VAC output; one Trace SW4024, 4,000 W, 24 VDC nominal input, and two OutBack FX2024, 2,000 W each, 8,000 W total, 24 VDC nominal input, series stacked for 120/240 VAC output

Engine generator: Onan GGDB 20 KW water-cooled, propane-fired, remote electric start, 240 VAC output; average yearly run time is 200 to 300 hours

System performance metering: Xantrex TM500A AH Meter, OutBack MATE, PC with RightHand Engineering software

Left: Four large, industrial quality, deep-cycle batteries provide energy storage for the island home.

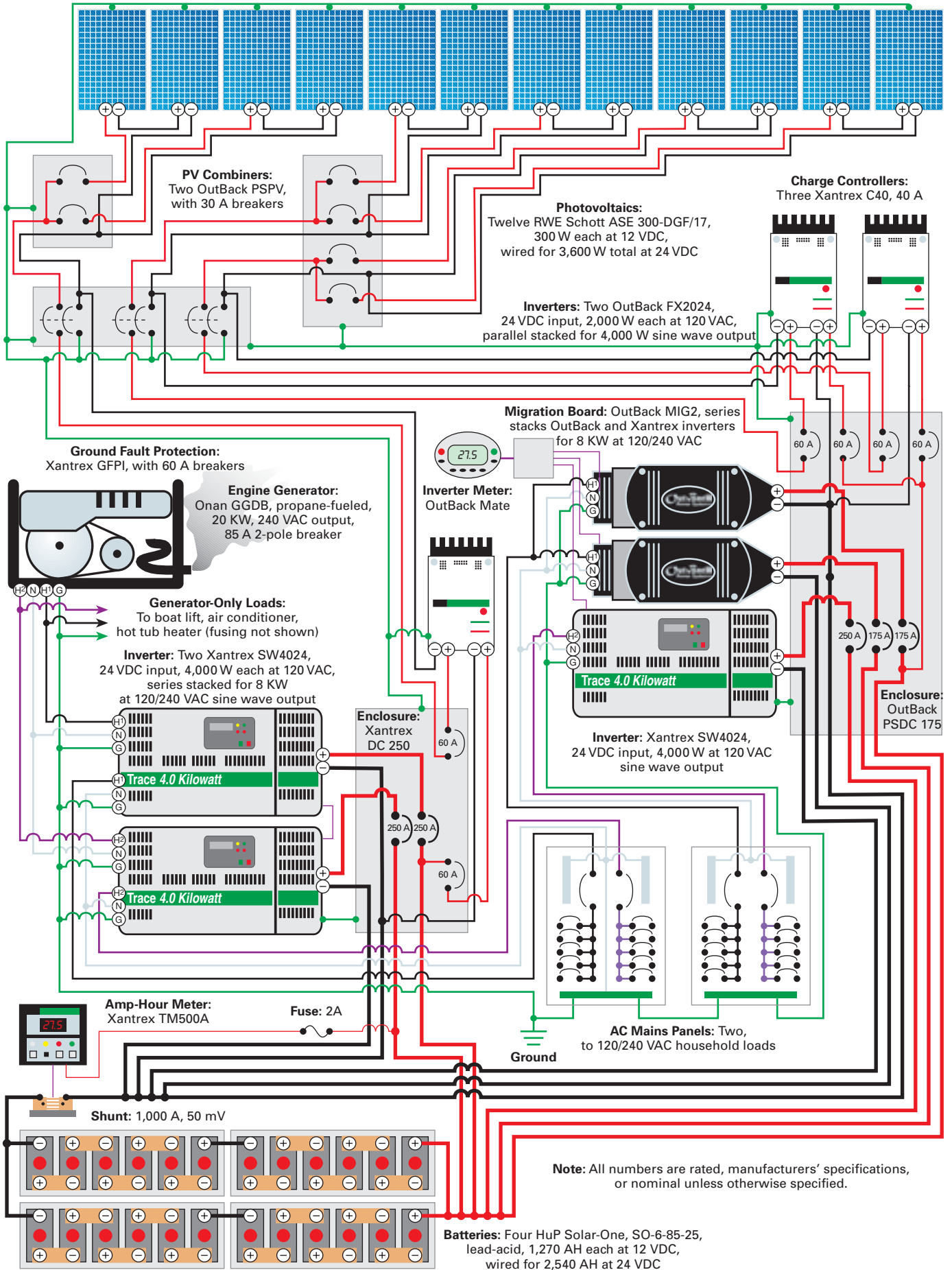

Inverter Migration Board

As a solar energy contractor in coastal Florida, I have installed and maintain more than 50 Xantrex SW-series inverters. The houses that these systems power are directly on the beach, and the extreme salt conditions constantly play havoc with electrical equipment. If the salt weren't enough, lizards, spiders, and all kinds of miniature creatures like to make inverters their homes. Wanting a permanent solution to this issue is what first brought the new OutBack Power Systems line of sealed inverters to my attention.

Most of my installations use the Xantrex serial-stacking feature, which synchronizes the output of two separate inverters to supply 120/240-volt output. The OutBack product line also provides this capability, but of course only when using two (or more) of their inverters. In October 2003, after eleven months of operation, one of the McVickers' inverters failed, leaving the system with one inverter stranded. This was a used inverter that was about three years old, and out of warranty.

OutBack to the Rescue

I called OutBack and spoke with the tech honchos about my dilemma. I wanted to use a pair of their inverters to replace one Xantrex inverter, but keep the second functioning Xantrex inverter and stack the three of them together. What we needed was a migration path to allow OutBack and Xantrex inverters to work together properly in a stacking configuration.

OutBack liked the concept and the technical challenge. A few weeks later, engineer Bob Gudgel called me and said he had the first "migration board" up and running! How soon could I install one for testing?

I planned to replace the failed inverter with two OutBack FX2024, 2,000-watt, sealed units. The parallel output from them would then be synchronized with the remaining 4 KW unit by using the new migration board, which is a modified OutBack Stack-4 communications manager. Monitoring was provided by OutBack's Mate product. The installation was a breeze. OutBack inverters are roughly 60 pounds (27 kg) each, so they are manageable by one person. The inverters connect to the migration board with supplied CAT5 cabling. I installed the board in a sealed Carlon J-box to protect it.

Phase Loss Management

The one caveat is that the board doesn't protect against the loss of phase. If either the OutBack or Xantrex stacked inverters shut down, the other will stay running, providing only 120 volts. The OutBack folks had a simple answer to prevent this issue from affecting equipment. They pointed me to a phase-loss protector device, model CV240AFN, which you can buy for US\$85 from Automatic Timing and Controls. Plug the 240-volt device into it, and the moment it detects a phase loss, it shuts off the electricity to the equipment.

Happy Camper

So how does it work? It has worked very well so far, after fourteen months of operation. Equipment that requires 240 volts seems quite happy. OutBack has dubbed the migration board the "MIG2" and added it to their product line at a retail price of US\$139.

This was my first installation of OutBack inverters. It has been a very positive experience working with the OutBack staff and their products. The systems are very well thought out, with many features already built in that make my life easier. And with the new MIG2, you can begin to enjoy the benefits of the OutBack inverters, while preserving the investment in currently functioning equipment.



Author and system installer John McNicholas with the first stacked Xantrex/OutBack inverter system made possible by the MIG2 migration board.

McVicker System Costs

Item	Cost (US\$)
12 RWE Schott ASE 300-DGF/17 PV panels	\$18,000
Onan 20 KW propane generator	12,000
3 Xantrex SW4024 inverters with conduit boxes	11,500
4 HuP Solar-One S0-6-85-25 batteries	11,500
2 OutBack FX2024 inverters	3,600
Module mounts, custom	1,000
OutBack PSDC-175 enclosure with 175 A & 250 A breakers	650
3 Xantrex C40 charge controllers	477
Xantrex DC250 enclosure with 250 A breakers	450
2 OutBack PSPV combiner boxes w/ breakers	400
Xantrex PVGFP-3 ground fault interruptors	375
OutBack Mate	300
TriMetric meter	200
OutBack MIG2 migration board	139
Total	\$60,591

two, 1,000-gallon (3,800 l) tanks prior to the weather season. It is an expensive proposition to say the least. So the initial capital expenditure for twelve, 300-watt solar-electric panels and a large battery bank has been well worth it.

The McVickers' tennis court has played host to local charity matches, as well as entertaining island neighbors. To provide some shade, a chickee hut (a thatched hut covered in palm fronds, native to south Florida) was built courtside, and outfitted with lights, a ceiling fan, an outdoor shower, and a water fountain. A solar-charged electric golf cart is used to shuttle the competitors out to the beach to cool off.

The house is used regularly on the weekends when the children are out of school. Leaving the cares of the world behind them as the family steps off the dock, a white shell path extends from the Intracoastal Waterway, beckoning them to the house and all it has to offer. Knowing that the sun is providing the electricity makes it all the more enjoyable.

Access

John McNicholas, Key Power Services, Inc., 160 Tahiti St., Naples, FL 34113 • 239-290-6040 • keypowerservices@comcast.net

Marie Barnett, Barnett Design Studio, 501 Goodlette Rd. N 208-C, Naples, FL 34102 • 239-649-5620 • 239-649-5402 • archologyinc@aol.com • Architectural design

John Cecil, Continental Construction, 1150 Central Ave., Naples, FL 34102 • 239-434-8437 • Fax: 239-434-0874 • johnc@ccnaples.com • www.ccnaples.com • General contracting, construction

Mark Colwell, Colwell Electric Inc., 340 Columbus Way, Marco Island, FL 34145 • Phone/Fax: 239-642-0458 • Electrician

Scott Williams, SPS Energy Solutions, 340 El Pueblo Ste. F, Santa Cruz, CA 95066 • 800-635-7497 or 831-440-9313 • Fax: 831-440-9345 • swilliams@spsenergy.com • www.spsenergy.com • Equipment supplier

RWE Schott Solar Inc., 4051 Alvis Ct. Ste. 1, Rocklin, CA 95677 • 888-457-6527 or 916-625-9033 • Fax: 916-625-9032 • rssales@rwechottsolar.us • www.rwechottsolar.us • Equipment supplier, PVs

Northwest Energy Storage • 800-718-8816 or 941-697-1344 • Fax: 941-697-0767 • batteries@nwes.com • www.hupsolarone.com • Batteries

OutBack Power Systems, 19009 62nd Ave. NE, Arlington, WA 98223 • 360-435-6030 • Fax: 360-435-6019 • sales@outbackpower.com • www.outbackpower.com • Inverters, DC disconnect, breakers, MIG2

Xantrex Technology Inc., 5916 195th St. NE, Arlington, WA 98223 • 360-435-8826 • Fax: 360-435-3547 • info@xantrex.com • www.xantrex.com • Inverters, DC disconnect, breakers, meter

RightHand Engineering LLC, 19310 226th Ave. NE, Woodinville, WA 98077 • Phone/Fax: 425-844-1291 • info@righthandeng.com • www.righthandeng.com • WinVerter software

Cummins Southeastern Power Inc., 5910 E. Hillsborough Ave., Tampa, FL 33610 • 813-664-5833 • Fax: 813-628-4183 • randolph.m.szurma@cummins.com • www.onan.com • Generator

Automatic Timing and Controls, State Rte. #2, Newell, WV 26050 • 800-727-5646 or 304-387-1212 • Fax: 304-387-3359 • mgoneau@marshbellofram.com • www.automatictiming.com • Phase-loss protector

Bogart Engineering (TriMetric), 19020 Two Bar Rd., Boulder Creek, CA 95006 • 831-338-0616 • Fax: 831-338-2337 • Bogart@bogartengineering.com • www.bogartengineering.com • TriMetric meter



PC Software for Sine Inverters

www.RightHandEng.com (425) 844-1291

affordable solar

Lowest Prices Under the Sun!

Welcome to Affordable Solar! Our staff has over two decades of solar electric system experience. Talk to us about how to design your own solar or wind energy system for on grid or offgrid location; how to choose the best solar powered water pumping system; how a composting toilet works; what is the best solar panel charge controller combination to use with your RV or marine application; and to learn when to choose a modified sine wave inverter versus a true sine wave inverter. We know!

Featured This Month

 **KYOCERA**

KC187G	187W	W/MC connectors	\$710
KC167G	167W	W/MC connectors	\$637
KC125G	125W		\$475
KC120	120W		\$454
KC80	80W		\$319
KC70	70W		\$292
KC60	60W		\$264
KC50	50W		\$219
KC45	45W		\$205
KC40	40W		\$189

MyGen 3000 Watt Gridtie Solar Electric System \$13,999

 **bp solar**

BP3160B	160W	24V	\$679
BP3125S	125W	12V	\$559
BP3125U	125W	12V	\$559
BP380U	80W	12V	\$379

 **Shell Solar**

Shell 175-PC	175W	24V	\$739
Shell 165-PC	165W	24V	\$699
Shell 85-PC	85W	12V	\$355
Shell 80-PC	80W	12V	\$328

SHARP

NT-175U1	175W	24V	\$699
ND-167U1	167W	16V	\$669
NE-165U1	165W	24V	\$629
ND-L3EJE	123W	12V	\$469
NE-80EJE	80W	12V	\$339

Complete Systems

1.5kW Solar Electric System for Off Grid Remote Home \$9,999

 **MORNINGSTAR**

TriStar TS-60 60 amp-hr \$179

AIRX Southwest Windpower
12V & 24V 400W Wind Turbine \$525

 **EVERGREEN SOLAR**

EC-110 12/24V \$444
EC-115 12/24V \$478

Servel Americana

RGE 400 8cu.ft Propane \$1,029

Crystal Cold
18cu.ft Propane Refrig/Freezer \$2,099

xantrex

Smart choice for power

Inverters-SW Plus Series
SW4024 Plus 4000W 24V
Series II
SW4024 4000W 24V
Call for Sale Price

 **SMI**

Sunny Boy 6000U
Sunny Boy 2500U
Call for Sale Price

Surrette Batteries

S-460 \$179
S-530 6V 530 amp-hr \$199

 **OutBack Power Systems**

VFX3524 3500W 24V
GVFX3648 3600W 48V
MX60 MPPT Charge Controller
Call for Sale Price

Solar Water Pumps

Grundfos SQ Flex Pumps
ETAPUMP Submersible Pumps
Call for Sale Price

Sun-Mar Composting Toilets

Excel NE \$1,075
Prices Subject to Change.

Featured Brands

 **KYOCERA**
KYOCERA Solar, Inc.

 **PV Powered**

 **MyGen**
MyGeneration

 **Fronius**

 **isolation**

 **bp solar**

 **SHARP**

 **OutBack Power Systems**

 **isolation**

 **MORNINGSTAR**

 **xantrex**

 **SMI**

 **Shell Solar**

 **Shell Solar**

 **EVERGREEN SOLAR**

visit www.affordable-solar.com



Just the right size for every customer.

Now you can deliver just the right level of grid tied inverter power output for every installation. Because with solutions from 2 to 5.1kW, FRONIUS IG Inverters offer more choices. More performance. And more reliability.

Advanced high-frequency technology also means Fronius inverters are lighter than the competition - as much as 70% lighter. Combined with built-in DC and AC disconnects, that makes installation easier. A lot easier.

Every Fronius inverter also offers everything else you'd expect from the leader in inverter technology. Like a user-friendly LCD, intelligent thermal management, and the easiest, most flexible performance monitoring available. All protected by a weather-tight design built to handle the harshest environments.

Get your next installation just right. Put our 60 years of inverter design and manufacturing experience to work for you, and for your customers.

Fronius USA LLC 5266 Hollister Avenue #117, Santa Barbara, CA 93111
Tel: 805-683-2200 Email: pv-us@fronius.com Web: www.fronius.com



POWERING YOUR FUTURE

Farming the Wind

Randy Brooks

©2005 Randy Brooks

Courtesy Rob Sanderson

Twin Bergey Excel wind generators harvest the wind in eastern Washington's dry hills.

June and Charlie Nichols' initial interest in renewable energy led to the installation of their first wind turbine in May 2002 (see "Betting the Farm" in *HP96*). In the two years since, their Bergey Windpower Excel-S, 10-kilowatt (KW), grid-tied wind turbine has been working hard. It has earned approximately US\$14,270 from the sale of electricity to the Chelan County Public Utility District's SNAP program, an innovative, customer-driven, renewable energy buyback program that has received national awards and stirred interest worldwide.

Randy Brooks (left) and crew attach the wind turbine to the tower, in preparation for the lift.



Purchasers are Chelan County, Washington, PUD customers who contribute an additional US\$2.50 or more each billing cycle to support renewable energy (solar, wind, and microhydro) production within Chelan County. This money goes into a fund that is used to pay producers a premium for the renewable energy they supply to the Chelan County PUD grid. One hundred percent of the funds contributed are used for this purpose.

About 700 customers currently contribute to the program. Producers were paid US\$1.50 per KWH (the program's cap) in 2002, US\$1.19 per KWH in 2003, and US\$0.71 per KWH in 2004. More systems have been installed each year. About 50 KW of PV and wind are installed, with more than 50 KW planned.

Although future SNAP program rates remain uncertain, the Nichols have already recouped almost 40 percent of the cost of their first turbine. This excellent rate of return, and their declining ability to actively farm their acreage due to health problems, led June and Charlie to decide to install a second wind turbine.

Second Turbine Costs

Item	Cost (US\$)
Bergey equipment (turbine, tower, inverter & tower wiring kit)	\$31,000
Labor	5,500
Materials (forms, rebar, concrete, conduit, wire, etc.)	6,500
Owner services (permits, excavation, freight, etc.)	2,600
Equipment rental (compactor, crane, etc.)	2,000
Total	\$47,600

The installation was very similar to the first turbine, described in *HP96*. The same core crew was used, with the addition of Scottish wind expert Hugh Piggott, who was in the United States to teach a wind workshop.

Bergey Windpower recommended that the two 100-foot (30 m) towers be separated by a minimum of 300 feet (91 m) to avoid one turbine disturbing the airflow for the second. Xantrex confirmed that the two GridTek 10 inverters could be wired in parallel without problems. The local utility reviewed the transformer and service wire size and confirmed that they could handle the additional output.

Once the preparatory work was completed, the crew gathered on April 20 and 21, 2004, to install the second turbine. Tower assembly and inverter wiring went well. The crew even had time to do some of the biennial maintenance on the first turbine, although high winds prevented accomplishing much on the checklist.

After completing the crane lift, cable tensioning, securing turnbuckles with safety cables, and commissioning tests, both turbines were left manually furling and electrically shorted until grid power could be connected. Several days later, the system passed electrical inspection. The PUD responded quickly to reconnect service to the SNAP production meter, and the two systems were energized.

Winds were measured at 20 mph (9 m/s) on the ground that day, and estimated at 30-plus mph (13 m/s) at turbine height, based on turbine furling action. The crew went through the start-up procedure carefully, since this was the first paralleled dual-inverter system the company had installed. The two GridTeks, the original Version A



A crane lifts the second Bergey Excel wind turbine on a 100-foot (30 m), guyed, lattice tower.

Dual GridTek inverters convert the three-phase wild AC output of the Bergey Excel wind turbines to grid-synchronous AC.





The crew installs the blades on the second Bergey Excel at the Nichols ranch.

After the first sixteen hours of operation, the two wind turbines had produced 234 KWH of clean energy, valued at more than US\$166 at current SNAP program rates. Now that's farming the wind!

Access

Randy Brooks, Brooks Solar Inc., 140 Columbia View, Chelan, WA 98816 • Phone/Fax: 509-682-9646 • info@brookssolar.com • www.brookssolar.com

June & Charlie Nichols, Kingsbury Wind Farm, 4300 Kingsbury Rd., Malaga, WA 98828

Chelan County PUD SNAP program, Jim White, PO Box 1231, Wenatchee, WA 98807 • 888-663-8121 or 509-661-4829 • Fax: 509-664-2889 • jamesa@chelanpud.org • www.chelanpud.org

Bergey Windpower, 2001 Priestley Ave., Norman, OK 73069 • 405-364-4212 • Fax: 405-364-2078 • sales@bergey.com • www.bergey.com

Xantrex Technology Inc., 5916 195th St. NE, Arlington, WA 98223 • 800-670-0707 or 360-435-8826 • Fax: 360-435-3547 • info@xantrex.com • www.xantrex.com



and the new Version B models, worked well together. With outputs above rated capacity—10 to 11 KW from the original system, and 11 to 12 KW from the new system—the individual inverter production meters and combined SNAP production meter were really spinning!

Working For Your Environment.

DEKA SOLAR
RENEWABLE ENERGY GEL BATTERIES

TECHNOLOGICALLY-ADVANCED AND ENVIRONMENTALLY-CONSCIOUS.

East Penn recycles 100% of scrap lead-acid batteries at our state-of-the-art, E.P.A. permitted recycling facility. In fact, we safely recycle 20,000 batteries a day on site.

We are the world's largest and most modern single-site battery manufacturer offering premium quality valve regulated lead acid batteries in both Gel and AGM types to exceed the solar industry's high standards.

QUALITY SYSTEM ISO 9001 PROVEN PRODUCT IN DEMANDING PHOTOVOLTAIC APPLICATIONS • LESS THAN 2% PER MONTH STAND LOSS MEANS LITTLE DETERIORATION DURING TRANSPORT AND STORAGE
U.L. RECOGNIZED COMPONENT • MINIMUM MAINTENANCE • COMPETITIVE WARRANTY • MADE IN THE U.S.A.

DOMESTIC INQUIRIES:
800-372-9253 • solarinquiries@mkbattery.com

EAST PENN manufacturing co., inc. INTERNATIONAL INQUIRIES:
610-682-3263 • www.dekabatteries.com

INTRODUCING The Guy-less Tilt-Down Tower!

- ✦ Available for turbine rotor diameters up to fifteen feet
- ✦ Safely operated by one person with ease
- ✦ Minimal footprint required
- ✦ Successfully field-tested in Montana for over five years

- ✦ Engineering analysis available
- ✦ Galvanizing available for coastal locations

✦ Provided as complete installation kit

Hybrid version consolidates wind and solar power generation

Hybrid Tower

INDEPENDENT POWER SYSTEMS

For further information including pricing and specifications: www.solarwindmontana.com



SOLECTRIA RENEWABLES

Grid-Tied PV Inverters



Commercial

Low cost, grid-tied, 1.8 to 75kW UL1741 certified inverters
 Integrated package minimizes total installed PV system cost
 Premium, efficient design maximizes energy production
 High precision maximum power point tracking
 High reliability – over 14 years of power electronics experience in harsh environments



Residential

www.solectriarenewables.com

What's Going On—The Grid?

A NEW GENERATION OF GRID-TIED PV INVERTERS

Joe Schwartz

©2005 Joe Schwartz

We all know that technology advances quickly. New and improved computers, cell phones, TVs, and other home electronics are always hitting the streets. Many of us have let out an anguished sigh after we opened up the new computer catalog, only to find that the laptop we bought six months ago has been replaced by a new model that's bigger, faster, and less expensive. Luckily, renewable energy gear rarely becomes "obsolete" the way computers do. But solar-electric equipment designs are evolving rapidly, and nowhere is this evolution more apparent than today's choices of grid-tied photovoltaic (PV) inverters.

Sizable financial rebates, favorable utility billing agreements for solar electricity, a professional installer base, and state-of-the-art equipment are all driving a rapidly growing grid-tied solar energy industry in the United States. Worldwide PV shipments grew by 32 percent in 2003, and 2004 showed an even larger increase. As the global grid-tied solar energy industry expands, so does consumer choice. More and more inverter manufacturers are stepping onto the playing field, and luckily for us, they're all swinging for the fence.

Inverters, Inverters, Inverters

Numerous grid-tie inverter manufacturers have both distribution and service networks here in the United States. I've selected one inverter from each of these manufacturers' product lines to highlight. In most cases, the manufacturers included here design and build several inverter models. So don't consider this to be a comprehensive list, but rather a starting point for selecting the inverter that's right for you and your application.

The specifications that I consider to be most important when selecting an inverter for a given application are included for each featured inverter. All listed specifications were provided by the manufacturers. For definitions of these specifications, take a look at the sidebar below. Other inverter specifications will come into play too. For comprehensive inverter information, download product specification sheets and inverter manuals from the manufacturers' Web sites, pour yourself a cup of coffee, and pore over them. Web addresses and other contact information are listed in the Access section at the end of this article.

All of the inverters detailed here are suitable for outdoor locations unless otherwise noted. Some include built-in AC and/or DC disconnects. These features are noted where applicable. Only UL or ETL listed inverters that are currently in production and shipping are included, but make sure to check upcoming issues of *Home Power* for information on new inverter models as they become available.

Specification Definitions

Maximum continuous output power. The AC output power in watts (W) that an inverter can deliver. Some inverters will limit their output power at elevated temperatures. Since no industry-wide standard test temperature has been established, the direct comparison of inverter power ratings is somewhat difficult. This article includes specific test temperatures along with the maximum continuous output power specification of each inverter.

Maximum recommended PV array power (STC). The maximum PV array peak wattage (Wp) that is suitable for a specific inverter. Some installers recommend sizing the array Wp at approximately 80 percent of this figure, which results in cooler inverter operation, and possibly increased inverter longevity. All PV modules have a rated peak power output at standard test conditions (STC). These standardized conditions have been established so direct module-to-module comparisons are possible. Technically, STC are an ambient temperature of 25°C (77°F) and an irradiance of 1 KW per square meter.

Maximum DC input voltage. The maximum PV open circuit voltage (Voc) an inverter is designed for. Array Voc increases as ambient temperature decreases, so the historical minimum temperature of a given site (as cold as it ever gets) is an important factor in array voltage sizing. Voltages that exceed the inverter's maximum DC input voltage rating will typically damage the inverter. Over-voltage-related failures are a result of faulty system design and are not covered by inverter warranties.

MPPT DC voltage range. The PV array voltage range that an inverter can effectively track to optimize the array's maximum power voltage (Vmp) and its output. PV arrays have a specific point on their voltage vs. current (IV) curve where they produce maximum power. This is referred to as the array's Vmp. An array's Vmp will vary throughout the day as weather conditions change. As array temperature increases, its Vmp will decrease. Proper array voltage sizing is crucial to efficient inverter operation, and varies depending on the specific climatic conditions of a given site.

Nominal AC voltage. The utility grid voltage that an inverter is designed to operate in conjunction with. In the United States, most grid-tie PV inverters have either a 120 VAC or 240 VAC nominal grid voltage requirement. Industrial or commercial electric services may be three-phase, and require inverters with a 208 VAC nominal voltage.

Warranty. The length of time that a manufacturer will repair failed equipment due to defective parts or workmanship free of charge. Like most products, the conditions of a given warranty are clearly defined, but vary widely. Read the details carefully. Extended warranties are available from some manufacturers at an additional cost.

List price. The manufacturer's suggested retail price (MSRP) in U.S. dollars. Street prices are often lower, but design assistance and technical support from below-list retailers will often be lower too.

Fronius

Fronius recently introduced three new inverters to their U.S. product line—the IG 4000, IG 4500-LV (208 VAC), and IG 5100. These inverters use the same hardware and software as the more than 60,000 Fronius/IG inverters operating worldwide, and are designed to support the larger system sizes we're seeing here in the United States. Fronius inverter models now range from 2,000 to 5,100 W. AC and DC disconnects come standard, and are factory integrated into each inverter.

Fronius IG 5100 (batteryless)

Maximum continuous output power: 5,100 W at 40°C (104°F)

Maximum recommended PV array power (STC): 6,500 Wp

Maximum DC input voltage: 500 Voc

MPPT DC voltage range: 150–450 V

Nominal AC voltage: 240 V

Warranty: 5 years

List price: US\$4,130



Magnetek

Magnetek currently manufactures two inverters for the U.S. market, the PVI-2000 and PVI-3000, rated at 2,000 and 3,000 W respectively. The PVI-3000 has dual array input circuits for independent peak power point tracking of two PV arrays. This creates installation flexibility when a given site requires mounting two PV arrays in different orientations, or when two module types are used. Four additional Magnetek inverters are undergoing UL certification for the U.S. market.

Magnetek PVI-3000-I-OUTD-US (batteryless)

Maximum continuous output power: 3,000 W at 45°C (113°F)

Maximum recommended PV array power (STC): 3,600 Wp

Maximum DC input voltage: 600 Voc

MPPT DC voltage range: 90–580 V

Nominal AC voltage: 240 V

Warranty: 5 years

List price: US\$2,995

PV Powered

PV Powered has three inverters in their product line—the PVP 1100, PVP 1800, and PVP 2800. Power ratings are 1,100 W, 1,800 W, and 2,800 W respectively. The PVP 1100 and PVP 1800 are 120 VAC nominal, making them well suited for smaller systems. The PVP 2800 is available at either 240 VAC or 208 VAC nominal. Integrated DC/GFI breakers are standard. PV Powered's standard 10-year warranty is the longest in the industry.

PV Powered StarInverter PVP 2800 (batteryless)

Maximum continuous output power: 2,800 W at 40°C (104°F)

Maximum recommended PV array power (STC): 3,700 Wp

Maximum DC input voltage: 450 Voc

MPPT DC voltage range: 200–390 V

Nominal AC voltage: 240 V

Warranty: 10 years

List price: Contact installer or equipment reseller





Sharp

Most people are familiar with Sharp electronic products—from notebook PCs to home theater systems. You may be surprised to hear that Sharp is the largest PV manufacturer worldwide, and also manufactures PV inverters. Sharp inverters are sold and installed exclusively by a network of Sharp certified dealers. The Sunvista JH-3500U inverter incorporates three array input circuits for the independent peak power point tracking of three PV arrays, ideal for sites requiring multiple array orientations.

Sharp Sunvista JH-3500U (batteryless)

Maximum continuous output power: 3,500 W at 40°C (104°F)

Maximum recommended PV array power (STC): 4,500 Wp

Maximum DC input voltage: 380 Voc

MPPT DC voltage range: 110–350 V

Nominal AC voltage: 240 V

Warranty: 5 years

List price: US\$3,500

SMA

SMA America first introduced their popular SB2500U inverter to the U.S. market in 2001. At the time, residential grid-tied solar electricity was still a fledgling industry in the states. SMA helped change that, and set a new standard in grid-tied inverter reliability and performance. The Sunny Boy line includes six inverters, from 700 to 6,000 watts, including the Windy Boy inverter designed for batteryless wind-electric systems. The new SB6000U inverter is geared toward large residential and small commercial applications.

SMA Sunny Boy 6000U (batteryless)

Maximum continuous output power: 6,000 W at 45°C (113°F)

Maximum recommended PV array power (STC): 7,500 Wp

Maximum DC input voltage: 600 Voc

MPPT DC voltage range: 250–480 V

Nominal AC voltage: 240 V

Warranty: 5 years (extended warranty available)

List price: US\$4,200



Xantrex

Xantrex Technology has moved away from their low voltage grid-tie inverter platform and recently introduced a newly designed, high-voltage string inverter—the GT 3.0. The GT 3.0 has undergone significant field and laboratory testing, and the results have been well received by established PV installers and distributors. The GT 3.0 includes an integrated, 600 V DC/AC PV–utility disconnect that enables an NEC-compliant inverter installation in a single box.

Xantrex GT 3.0 (batteryless)

Maximum continuous output power: 3,000 W at 35°C (95°F)

Maximum recommended PV array power (STC): 3,750 Wp

Maximum DC input voltage: 600 Voc

MPPT DC voltage range: 195–550 V

Nominal AC voltage: 240 V

Warranty: 5 years (10-year extended available, US\$400)

List price: US\$2,500

Beacon Power

Beacon Power manufactures the Smart Power M5, battery-based grid-tie inverter. The M5 uses a single, outdoor-rated enclosure to house an inverter, MPPT charge controller, DC PV breakers, ground-fault protection, and AC output breakers. An optional battery breaker and series PV combiner are required for code-compliant operation. The M5's AC load transfer time from grid to battery power is less than 32 milliseconds, and fast enough to act as a computer UPS system in most applications. An optional autotransformer is available for 240 VAC output.

Beacon Smart Power M5 (battery based)

Maximum continuous output power: 5,000 W at 40°C (104°F)

Maximum recommended PV array power (STC): 6,000 Wp

Maximum DC input voltage: 110 Voc

MPPT DC voltage range: 50–85 V

Nominal DC battery voltage: 48 V

Nominal AC voltage: 120 V

AC load transfer time: Less than 32 ms

Warranty: 5 years

List price: US\$6,999



OutBack Power Systems

OutBack Power Systems manufactures four battery-based, grid-tie inverters—the GTFX2524 and GTFX 3048 are environmentally sealed for outdoor or extreme locations. The GVFX3524 and GVFX3648 are higher power, vented units. Two or more OutBack GFX inverters can be series stacked for 120/240 VAC output. AC transfer time is less than 4 milliseconds. OutBack also manufactures the MX60 MPPT charge controller. When used together, GFX inverters and MX60s create a very flexible and efficient grid-tie system. OutBack also offers the PS1, outdoor-rated, prewired grid-tie system with battery enclosure for turnkey installations.

OutBack GVFX3648 (battery based)

Maximum continuous output power: 3,600 W at 25°C (77°F)

Maximum recommended PV array power (STC, with optional MX60 controller configured for 48 VDC nominal output): 3,500 Wp

Maximum DC input voltage (MX60 controller): 150 Voc

MPPT DC voltage range (MX60 controller, 48 VDC nominal battery bank): 48–100 V (optimum)

Nominal DC battery voltage: 48 V

Nominal AC voltage: 120 V

AC load transfer time: Less than 4 ms

Warranty: 2 years (GVFX3648, extended available); 5 years (PS1)

List price: US\$2,345; US\$4,999 estimated (PS1-GVFX3648)

Choices, Choices, Choices

Grid-tied PV inverters have one primary job—process the energy a solar-electric array produces, and feed as much of it as possible to the utility grid. Several factors affect how effectively and reliably a given inverter will accomplish this task. Your inverter choice should not be based on one characteristic alone, like cost, peak efficiency, or the PV voltage range. An array of choices must be considered, and the optimal system design and inverter choice for you will vary depending on your site and energy requirements.

Most grid-tied PV systems are professionally designed and installed due to installation complexity, the long list of electrical code requirements that must be met, and rebate specifics that may dictate installation by a licensed electrician. Professional system installers will likely be your best resource for sound advice on which inverter and system will serve you best.

One tool that pros have and end users don't is years of experience designing systems, installing a variety of equipment, and firsthand data related to how well different inverter designs function in the field, and under what site conditions. If you plan to install a system yourself, do your homework, or you may be disappointed with your investment in solar energy. Even the best equipment will fail to perform as expected if the system as a whole is poorly designed or installed.

Answers to Some Basic Questions

Should I include batteries in my grid-tied solar-electric system? The vast majority of grid-tied solar-electric systems use batteryless inverters due to lower initial system cost, greater system efficiency, and more compact installations. The downside is that batteryless systems are designed to shut down when the grid does.

Battery-based grid-tied inverters charge a battery bank, provide an automatic backup electricity source, and feed solar energy onto the grid. In the past, battery-based, grid-tied systems have performed at much lower overall efficiencies than their batteryless counterparts. Today, new battery-based inverter designs have narrowed this gap considerably.

If you're trying to decide whether or not to have a batteryless system, ask yourself the three following questions. "When was the last utility outage? How long did it last? How much did it affect me?"

If your response is along the lines of, "The grid went out a couple of months ago and it was down for a few minutes. I had to reset the clock on the stove and the one in the bedroom, but other than that, it really didn't inconvenience me much," then a batteryless system is for you.

On the other hand, if your answer goes something like, "Last winter an ice storm knocked out the utility for nearly a week, just like the year before. I had no heat or running water. I couldn't work because my computer was down, and worst of all, I couldn't flush the toilet," a battery-based system might be a good choice.

Why is this inverter so much more expensive than that one? All manufacturers price their inverters to be competitive with similar products, while still allowing

them to cover their operating costs, provide solid customer support, and ultimately grow their business.

Inverter cost will vary primarily on the design of the inverter, ease of manufacturing, power ratings, and the features it provides. While cost is likely the dominant factor that you base your purchasing decisions on, the inverter you choose needs to do what you need it to do, and do it well.

Are grid-tie inverters safe? Local utilities and electrical inspectors familiar with PV inverters view them as just another appliance. All of the grid-tied inverters introduced in this article are listed for safety by UL or ETL. These are the same agencies that certify all the electrical appliances and products in your home or office for safe operation. This ensures that the inverter you're purchasing is safe for you, your family, and utility service workers.

What do I need to know about efficiency? All inverters have a peak efficiency figure. The peak efficiencies of the inverters detailed in this article range from 92.4 to more than 95 percent. While peak efficiency is important, a combination of operating characteristics actually determine what percentage of a PV array's output is converted to usable AC kilowatt-hours (KWH). Array voltage, the effectiveness of the inverter's maximum power point tracking (MPPT) algorithms, its performance at elevated temperatures, and its peak conversion efficiency together determine the overall operational efficiency of the inverter.

Does a grid-tied PV system need a charge controller? These days, most charge controllers have two primary functions—optimize PV output power with MPPT, and enable proper charging of the battery bank. Batteryless inverter systems don't have batteries, so a charge controller isn't needed. MPPT capabilities are built into the inverter itself.

Battery-based, grid-tie systems *do* require a charge controller, although it may be built into the system at the factory. Under normal grid-tie operation, once the battery bank is fully charged, all additional PV output is converted to AC and fed to the utility grid. In these systems, charge controllers serve two main functions—optimize the PV array output with MPPT, and protect a battery bank from overcharging if the grid goes down.

Will the inverter monitor the status of my system? Modern grid-tie PV inverter designs have an ever-increasing ability to track the operation of both your inverter and your PV system. This is great news for all you data junkies who want to check in on the status of your systems from your laptop over the wireless network at your local espresso bar. Advanced system performance monitoring allows you to see into the invisible world of your solar-electric system, and provides valuable information if system troubleshooting is required.

Most inverters have built-in LCD displays, and the option of connecting remote inverter monitors inside your home or office. The information these monitors display varies widely from manufacturer to manufacturer, but can include PV array voltage and current, grid voltage and frequency, inverter current and power, total energy

gear: inverters

(KWH) produced for various time frames, the amount of carbon dioxide your system has offset, inverter fault or error conditions—you name it!

Data connection options vary too. RJ-11, RJ-45 Ethernet connections, RS232, and RS485 connections to your PC, power-line data transfer (data transmitted over existing AC wiring), even wireless desktop inverter monitors are available. If in-depth system performance data is what you're after, make sure to thoroughly research both the hardware and software monitoring capabilities of the inverters that interest you.

Access

Joe Schwartz, *Home Power*, PO Box 520, Ashland, OR 97520 • 541-512-0228 • joe.schwartz@homepower.com • www.homepower.com

Beacon Power Corp. 234 Ballardvale St., Wilmington, MA 01887 • 888-938-9112 or 978-694-9121 • Fax: 978-694-9127 • sales@beaconpower.com • www.beaconpower.com

Fronius USA LLC, 5266 Hollister Ave. #117, Santa Barbara, CA 93111 • 805-683-2200 • Fax: 805-683-2220 • pv-us@fronius.com • www.fronius.com

Magnetek Inc. N50 W13605 Overview Dr., Menomonee Falls, WI 53051 • 866-381-2035 or 262-252-6982 • Fax: 262-790-4142 • aesales-us@magnetek.com • www.alternative-energies.com

OutBack Power Systems, 19009 62nd Ave. NE, Arlington, WA 98223 • 360-435-6030 • Fax: 360-435-6019 • sales@outbackpower.com • www.outbackpower.com

PV Powered LLC, 160 SW Scalehouse Loop #208, Bend, OR 97702 • 541-312-3832 • Fax: 541-383-2348 • info@pvpowered.com • www.pvpowered.com

Sharp Electronics, Solar Systems Division, 5901 Bolsa Ave., Huntington Beach, CA 92647 • 800-SOLAR06 or 714-903-4600 • Fax: 714-903-4858 • sharpsolar@sharpsec.com • www.sharp-usa.com/solar

SMA America Inc., 12438 Loma Rica Dr. Unit C, Grass Valley, CA 95945 • 530-273-4895 • Fax: 530-274-7271 • info@sma-america.com • www.sma-america.com

Xantrex Technology Inc., 5916 195th St. NE, Arlington, WA 98223 • 800-670-0707 or 360-435-8826 • Fax: 360-435-3547 • info@xantrex.com • www.xantrex.com



PV Powered

**Maximize Your PV Array,
Install a StarInverter Today!**

PV Powered Inverters Speak for Themselves:

- True Continuous Output Power at 2800, 1800 and 1100 Watts
- Lowest Parts Count = Highest Efficiency = Highest Reliability
- Low Price Leader, Made in the USA
- Backed by a 10-Year Warranty

PV Powered • Bend, Oregon • www.pvpowered.com • 541-312-3832

Inverter Service Company

a division of Direct Power and Water

- Authorized Service Center for Xantrex Inverters
- Authorized Service Repair and Sales of Mitsubishi UPS (7.5kva to 350kva)
- Certified Xantrex Dealer
- Largest inventory of SW, DR parts in North America
- Fastest turn around time in the WEST



Albuquerque, NM

Erich Lindner

Master Electronics Technician
erichl@directpower.com

Daniel Duffield

Electrical Engineer
dand@directpower.com

1-800-260-3792

www.directpower.com

Battery Filling Systems

Put the fun back in watering your batteries!



- **One Connection**
- **One Minute**
- **Accurately Fills Each Cell, Every Time!**

See Product Review,
Home Power Magazine
Issue 100, Page 82

Master Distributor for BFS, deep cycle & industrial batteries

All Battery Sales & Service



1-800-562-3212

Fax: 425 742-1739

vern@allbatterysalesandservice.com

As Reliable As The Sunrise

At **APOLLO SOLAR**, WE'VE BEEN DESIGNING INDUSTRIAL STRENGTH PRODUCTS FOR YEARS.

SO WHEN IT CAME TIME TO BUILD OUR **CHARGE CONTROLLERS** AND **INVERTERS** FOR THE RESIDENTIAL AND COMMERCIAL **PV** MARKETS, WE USED THAT EXPERIENCE TO CREATE THE MOST RELIABLE PRODUCTS AVAILABLE.

THE RESULT: STATE-OF-THE-ART SYSTEMS WITH THE LONGEST STANDARD WARRANTY ON THE MARKET – **10 YEARS**.

VISIT US ON OUR WEBSITE AND SEE THE DIFFERENCE.....

www.apollo-solar.net

Photograph courtesy of NASA

MPPT
CHARGE CONTROLLERS,
GRID-TIE INVERTERS,
BACK-UP POWER SYSTEMS,
ENERGY METERS



23 Francis J. Clarke Circle, Bethel,
CT USA 06801. Tel.: +1 (203) 790-6400

SEI Hands-On Workshops



Colorado Workshops

- Intro to Straw Bale Construction April 8 - 10
- Solar & Radiant Heating Systems April 28 - 30
- PV Design & Installation May 9 - 20
- Successful Solar Business May 21 - 22
- Advanced Photovoltaics May 23 - 27
- Solar Hot Water May 31 - June 3
- Solar Home Principals June 6 - 10
- Designing & Building Natural Homes June 13 - 17
- RE for the Developing World June 20 - 24
- Hydrogen & Alternative Vehicles June 25 - 26
- Biodiesel June 27 - July 1
- Carpentry Skills for Women June 27 - July 1
- PV Design & Installation July 11 - 22
- Women's Photovoltaics July 11 - 22
- Successful Solar Business July 23 - 24
- Advanced Photovoltaics July 25 - 29
- PV Industry Week Aug 1 - 5
- Micro-Hydro Power Aug 1 - 5
- Solar Water Pumping Aug 6 - 7
- Wind Power Aug 8 - 19
- PV Design & Installation Aug 22 - Sep 2

PV Design & Installation Outside of Colorado

- Olivebridge, NY Mar 28 - Apr 2
- Austin, TX Apr 4 - 9
- Salt Lake City Apr 18 - 23
- Guemes Island Oct 10 - 15

Other Workshops Outside of Colorado

- Carpentry Skills for Women, OR Jun 27 - Jul 1
- Utility Interactive PV, NJ Sept 12 - 14
- Intro to Renewables, WA Oct 8
- RE for the DW, Nicaragua Oct 17 - 23
- Micro-Hydro, WA Oct 17 - 21
- Wind Power, WA Oct 24 - 29

Call for Our 2005 Catalog

HANDS-ON EDUCATION FOR A SUSTAINABLE FUTURE



SOLAR ENERGY
INTERNATIONAL

PO Box 715 - Carbondale, CO 81623
tel: 970-963-8855 - fax: 970-963-8866
sei@solarenergy.org

WWW.SOLARENERGY.ORG

Reliability and now Flexibility



One turbine, any voltage (12-48V)



With new looks and new names, the Whisper 100 (formerly the Whisper H40) and the Whisper 200 (formerly the Whisper H80) are more reliable and quieter than ever. We are constantly testing, researching and refining our products to create the most affordable and reliable small wind turbines available. Now you can warranty your Whisper for 5 years with approved siting and installation, just one more reason to get yours today.

New angle governor bushing

Voltage is field adjustable

New four bearing spindle

Upgraded yaw shaft



Southwest Windpower
Renewable Energy Made Simple

1801 West Route 66
Flagstaff, AZ 86001 USA
Tel 928-779-9463 • Fax 928-779-1485
www.windenergy.com • info@windenergy.com

80 Years of Building Better Batteries

- Performance engineered for durability, reliability and maximum capacity
- Flooded or valve-regulated (VRLA) products
- Live technical support or visit www.trojanbattery.com
- Trojan is the world's #1 manufacturer of deep cycle batteries for renewable energy systems



Available from Master Distributors Worldwide
800-423-6569 • www.trojanbattery.com
Trojan - Clean energy for life™

Building with SIPs



An Introduction to Structural Insulated Panels

Patrick Sughrue

©2005 Patrick Sughrue

Getting the sun's energy into a building is easy, but making good use of it is both an art and a science. How can this heat energy best be retained in the home for use when you need it? One answer is to use structural insulated panels (SIPs) for some or all of your walls and ceilings.

Good passive solar design starts with a very efficient envelope, comprised of the floor, walls, roof, windows, and doors. Each component plays a distinct role in achieving heat retention. How these parts are incorporated into a solar building will be influenced by overall expense, aesthetics, interior and exterior finishes, and structural load requirements.

Throughout history, methods of building walls have been dictated by the local climate and the natural resources available. Wall building systems have included earthen or rock walls, timber frames with cob infill, solid wood, and modern stick-frame construction. Today, increased demands for labor, material, and energy efficiency are changing the way we build and the materials we build with. Conventional materials, like wood, are being married to new substances to create buildings that are more energy and material efficient than ever before.

SIPs & Solar Energy

I first became involved with SIPs in the late 1970s while designing a passive solar home in Hood River, Oregon. At that time, passive solar homes were using double walls as thick as 12 inches (30 cm) with plastic air barriers and lots of labor to air-seal them. In 1988, I helped erect a SIP-integrated, timber-frame home in central Oregon. It was apparent—here was a simple system that provided superior insulation and exceptional air-sealing in one easy step.

Although SIPs aren't a new technology—they've been around for several decades—they are gaining popularity as an alternative to conventional stick-frame construction. A SIP consists of two outer skins, generally oriented strand board (OSB), with a 4- to 12-inch (13–30 cm) inner core of expanded polystyrene (EPS). Some manufacturers use polyurethane foam or even compressed straw between the OSB skins. The components are pressure-laminated together to make one structural unit.

SIPs offer insulating values from R-15 to R-45, depending on the thickness of the panel. In standard wood-frame construction, one-quarter of the entire wall area can consist

of solid wood, which has a value of only R-1 per inch. Contrary to popular belief, an R-21 batt does not create an R-21 wall. The insulating value of a wall is the R-value of all the materials used. Steady-state R-values, used by code officials, only consider where the insulation is, without accounting for thermal bridging at the studs, headers, or window framing.

SIPs address this problem by providing continuous insulation, with minimal thermal bridging. Six-inch (15 cm) panels have a 58 percent higher whole-wall R-value than a standard 2 by 6 stick-frame wall. SIPs have far fewer interruptions in the insulation, spanning widths from 4 to 24 feet (1.2–7.3 m), while the insulation in stud-framed walls is interrupted every 16 to 24 inches (40–61 cm). This makes SIP structures significantly more airtight, and in turn, makes a building more comfortable and energy efficient. In passive solar designs, the high resistance to heat flow in SIP walls and roofs protects concrete slabs and interior mass from losing heat to the outside environment.

Other Advantages

Besides being well suited for passive solar design, SIPs have other excellent qualities. SIPs can be custom fabricated for each project, making home design and construction as versatile as conventional stick-frame construction.

SIPs can be slightly more expensive than the materials used in stick-frame construction. But by combining three stages of conventional shell construction—framing, sheathing, and insulation—into a single unit, a SIP structure can be erected much faster and with less specialized labor than conventional stick-building methods, cutting construction time and labor costs.

Reducing Infiltration

Leaky walls allow warm or cold air to be sucked through a building, resulting in drafty, uncomfortable, and energy inefficient spaces. Infiltration through standard stud-constructed walls is very difficult to prevent. And although solid wall systems, like SIPs and insulating concrete forms (ICFs), can reduce drafts significantly, any wall penetrations—such as windows and doors—can contribute to leakage in either direction.

To get the best performance from any wall system, these penetrations must be sealed properly. But be sure to provide adequate building ventilation, both for the health of the building and for its occupants. Depending on your climate, this can be accomplished in a variety of ways, from opening a window to installing an efficient heat-recovery ventilator. Current building science indicates 0.33 air changes per hour (ACH) as a good goal for residential construction.



The Sughrue home in Vancouver, Washington, integrates SIPs and recycled timbers for energy and resource efficiency. Built in 1999, heating bills have averaged only US\$350 per year.

And using SIPs typically results in straighter walls than standard stick-framed systems.

Floor and wall SIPs require only standard hand and power tools, with the exception of a beam cutter attachment for a circular saw (like a Prazi beam cutter) and a hot knife if you are fabricating your own wall panels. Roof SIPs need a small boom truck, small crane, or material lift to raise them to roof level.

SIPs meet all building codes and perform well in fire tests. The lack of oxygen within the panels' rigid EPS foam core helps prevent combustion. When covered with an appropriate thermal barrier, like gypsum board, SIPs meet all national fire safety standards and the *International Building Code*.

SIP manufacturers can include wiring chases inside the panels at outlet height in walls, and holes can be cut for outlets where needed. Wiring for light switches, which are generally located near door frames, can be run up the SIP edge before inlaying the door frame. For areas like kitchens where lots of wiring and plumbing are needed, 2 by 4 false walls can be added to the SIP's interior face to accommodate the wires and runs. Plumbing should never be run within SIP walls, just as it should not be run within conventionally framed outer walls. In cold weather, this practice can put pipes at risk for freezing.

Above all, one of the features builders like best about SIPs is the ease with which they integrate with other building systems.

SIPs & Sustainability

The wood used in SIPs is typically harvested from fast-growing, small-diameter trees instead of from old-growth forests. But experts remain divided over whether SIPs save wood. Although SIP construction generally uses less dimensional lumber (up to 50 percent less than a conventional stick-framed home), overall wood savings may only be about 5 percent, due to the fact that SIPs use wood sheathing on *both* sides of a wall.



With logs having an insulation value of only R-1 per inch of wood, adding SIPs to the roofing system of this home makes the whole building more efficient.

SIP Wall & Roof Cross-Section

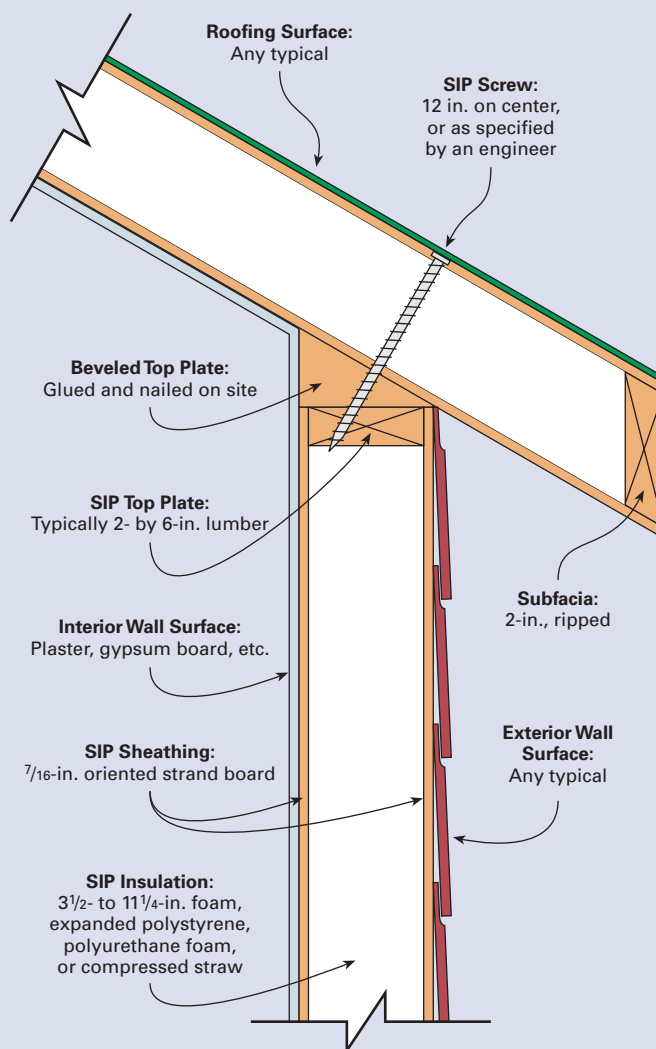

One environmental concern about SIPs is their foam core. Polyurethane foam cores in SIPs used to contain hydrofluorocarbons (HFCs), which cause ozone depletion. However, polyurethane foam production has recently changed and only accounts for a fraction of the SIP market. Most manufacturers use EPS, a thermoplastic that, expanded with pentane and steam, does not use or release any HFCs during its manufacture. Both polyurethane and EPS foams are derived from and manufactured using petroleum,

Roof Systems

Many of the criteria that apply to walls also apply to efficient solar roofs—high R-value, low air leakage, ease of construction, and cost. Building science research indicates that putting insulation in the roof plane instead of the ceiling is a superior energy-saving strategy. Keeping the heat and cold out of the building in the first place makes it much easier to control the building's interior temperature.

A couple of strategies already used by timber-framers and log homebuilders can allow you to move the insulation to the roof plane. Timber or log-framed rafters with 2 by 6 wood ceiling boards and a built-up foam roof is one option. Another strategy is to incorporate SIPs with a support system of logs, timbers, glue-lams, or trusses. Depending on the roof design, trusses or hand framing may be the only option. At the very least, use factory trusses with an energy heel so you can get full-depth insulation all the way out to the outside edge of the wall.

which adds another level of complexity to establishing their eligibility as a green building material. And, although EPS is a plastic that can be reclaimed and remanufactured into other products, bonding it to OSB makes it difficult to recycle.

Some experts argue that SIPs' energy savings over a building's lifetime make up for their fossil fuel-based components. "Although it takes about 40 gallons (265 l) of petroleum to make enough foam for a 2,000-square-foot (186 m²) home," says one energy analyst, "using SIPs can save approximately 60 gallons (227 l) in equivalent energy in the building's first year alone." The Florida Solar Energy Center found that using SIP construction can account for household energy savings between 12 and 17 percent.

One alternative to foam-core SIPs is a product called Agriboard (see Access). Agriboard panels use compressed wheat-straw, an agricultural waste material, as the insulative core. The straw is compressed under high temperatures and pressure; no additional binders are needed beyond the

adhesive used to bind the straw core to the OSB. Insulation values, which range from R-14.7 in the 4³/₈-inch (11 cm) panel to R-25 in the 7⁷/₈-inch (20 cm) panel, compare to standard EPS SIPs' values.

"More than 90 percent of the Agriboard panel core is made from a raw waste material—wheat straw—that is annually renewable," says Jesse Kemp, Agriboard's Director of Engineering. "And any waste we produce at the plant can be easily recycled—the waste straw can be put out to let nature take its course." Using waste straw this way gives local farmers an additional cash crop, and, Kemp says, also offers some environmental savings. "The farmers would either have to burn the straw or take the effort to till it under. Both activities create pollution. Instead, we take the waste wheat-straw and put it to good use."

The Best Wall

Besides SIPs, other energy efficient wall systems include insulating concrete forms (ICFs), which consist of a hollow



Versatile SIP gable walls and roofs can accept a variety of interior finishes.

OSB & Off-Gassing

Widely used in manufactured building materials and numerous household products, such as fiberglass insulation, cabinetry, and shelving, formaldehyde's most significant use in homes is as an adhesive binder used in engineered wood products such as particleboard and oriented strand board (OSB).

The Environmental Protection Agency (EPA) classifies formaldehyde as a "probable human carcinogen," exempting it from the Clean Air Act standards that govern hazardous air pollutants. However, the EPA is considering a September 2004 report from the World Health Organization International Agency for Research on Cancer that classifies formaldehyde as a "known human carcinogen."

There are two types of formaldehyde—urea formaldehyde and phenol formaldehyde. Products made with urea formaldehyde can off-gas significant levels of formaldehyde gas. Products made with phenol formaldehyde generally emit much lower levels of the gas.

OSB panels contain a very small percentage of phenol formaldehyde in the resin that helps hold the wood fibers together. Tests of formaldehyde from newly manufactured panels conducted by the EPA showed emissions below 0.1 parts per million. In fact, the levels were so low and so close to background levels in the test chamber that accurate measurements were not possible.

foam-block wall reinforced with rebar and then filled with concrete, or autoclaved aerated concrete (AAC) solid-block walls that offer good insulative value in a lightweight building block. An old idea that is undergoing resurgence is straw bale infill between a load-bearing frame. Other systems also have been designed to improve standard frame walls—one that is gaining popularity is wood framing combined with spray soy-foam and an exterior foam wrap.

So which wall is the best wall? It depends. Make a list of the characteristics that are most important to you and then compare wall systems that you think would work best with your building's design. If you know, for example, that you want to use an earthen clay finish on interior walls or stucco for the exterior finish, perhaps an ICF like Rastra, Apex, or Durisol might be your best choice. If construction speed or high R-value is the most important factor, then having large SIPs with pre-installed lumber delivered to the building site might be your best bet. Whatever the case, before you make a decision, do your research, ask plenty of questions, and get independent third-party opinions.

With sustainable living as the goal, green building, energy conservation, and renewable energy are only part of the larger picture. You will want to take an over-reaching view of your whole construction project as a sustainable process. There is no one perfect building material—only more appropriate products to match your set of parameters and goals.

Access

Patrick Sughrue, Structures NW, 15206 NW 29th Ct., Vancouver, WA 98685 • 360-576-6311 • Fax: 360-397-7105 • patrick@structuresnw.com • www.structuresnw.com

Structural Insulated Panel Association, PO Box 1699, Gig Harbor, WA 98335 • 253-858-7472 • Fax: 253-858-0272 • staff@sips.org • www.sips.org • General SIP information

Agriboard Industries, 100 Industrial Dr., Electra, TX 76360 • 866-495-3595 or 940-495-3590 • Fax: 940-495-3597 •

info@agriboard.com • www.agriboard.com • SIPs made with a compressed wheat-straw core

Apex Construction Systems Inc., 15930 SW 72nd Ave., Portland, OR 97224 • 800-252-8784 or 971-222-0006 • Fax: 971-222-0182 • info@apexconsys.com • www.apexconsys.com • Apex-Panel (ICF) systems

Durisol Building Systems Inc., 67 Frid St., Hamilton, Ontario, Canada L8P 4M3 • 905-521-0999 • Fax: 905-521-8658 • info@durisolbuild.com • www.durisolbuild.com • Durisol (ICF) systems

E-Crete • 2151 E. Broadway Rd. #115, Tempe, AZ 85282 • 888-432-7383 or 480-596-3819 ext. 11 • info@e-crete.com • www.e-crete.com • E-Crete (ICF) systems

Florida Solar Energy Center, 1679 Clearlake Rd., Cocoa, FL 32922 • 321-638-1000 • Fax: 321-638-1010 • info@fsec.ucf.edu • www.fsec.ucf.edu

Insulating Concrete Forms • www.icfweb.com • General ICF information

Precision Panel Structures Inc., 1447 E. State St., Eagle, ID 83616 • 208-939-2610 • Fax: 208-939-9905 • info@precisionpanel.com • www.precisionpanel.com

Prazi USA, 246 S. Meadow Rd., Plymouth, MA 02360 • 800-262-0211 or 508-747-1490 • Fax: 508-746-8655 • info@praziusa.com • www.praziusa.com • Prazi beam cutter circular saw attachment

Rastra Corp., 7621 E. Gray Rd. Ste. A1, Scottsdale, AZ 85260 • 877-935-3545 or 480-443-9211 • Fax: 480-443-9228 • info@rastra.com • www.rastra.com • Rastra (ICF) systems

The IronStraw Group, IronStraw Institute, 332 SE Third St., Oakland, OR 97462 • 541-817-5756 • info@ironstraw.org • www.ironstraw.org



NORTH CAROLINA SMALL WIND INITIATIVE'S 2005 WORKSHOP SERIES

The workshops will include hands-on activities and will be held at the Small Wind R & D site with 6 turbines operating.

- April 15 & 16: Wind Resource Assessment
- May 21 & 22: Small Scale Wind Energy with Robert Pears of Abundant Renewable Energy
- June 25 & 26: Small Scale Wind Energy with the Bergley Windpower Co.
- September 17 & 18: Southwest Windpower H80 Grid-Tie Installation Workshop

Bachelors and Masters degree programs also available.
email: wind@ncstate.edu
(828)262-7333 www.wind.ncstate.edu

Appalachian ENERGY

RADIANT & SOLAR

Radiant is the most efficient way to heat with the sun's energy. Connect right to a solar water heater for added comfort and efficiency.

- SAVE ON FUEL COSTS
- RETROFIT EXISTING STRUCTURES
- BUY DIRECT & GET LOWEST PRICES
- SIMPLE DO-IT-YOURSELF PACKAGES

Radiantec SINCE 1984

www.radiantec.com 800.451.7593

Beautifully Crafted Yurts Designed to be the best.

- Outstanding wind and snow load
- State-of-the-art materials and technology
- Hand-crafted quality

Since 1896

RAINIER YURTS **866.839.8787** www.RainierYurts.com

The TriMetric

Model 2020

BATTERY SYSTEM MONITOR



Displays vital battery system data to help users provide better battery care, increase conservation awareness and aid system maintenance.

- Volts • Amps • Amp-hours • Min/Max volts
- Days since charged • Battery % full
- Remote locatable • More !

Bogart Engineering • (831) 338-0616

www.bogartengineering.com

19020 Two Bar Rd. Boulder Creek, CA 95006 USA

The PentaMetric

SOON: A NEW BATTERY SYSTEM MONITOR



When you need A LOT MORE than a TriMetric

- 3 amp/amp-hour channels/2 volts channels: 2 battery systems and/or solar & wind inputs • 29 different (Battery DC) data
- Complete control from remote display unit and/or from "Windows" computer • Output control for generator start or battery alarms • Audible/visual alarms for low or high battery • Customize display to show only data you want • Print your own label to identify switches • Complete data logging designed to identify system problems

UPDATED Anticipated System Price: OOPS! Our actual cost turned out higher than we estimated before! About \$320 (with computer interface only), \$419 (with front panel display only). About \$519 for both.

We expect to have the PentaMetric generally available this summer, after incorporating the information from our beta test. We appreciate the response to our request for beta testers. We now appear to have enough to distribute the initial 50 units. For the most recent info, visit website.

Your Solar Solutions Start Here.



We offer a comprehensive range of renewable energy products for residential and commercial applications including:

- **BP Solar Modules**
- **Inverters from Outback, Xantrex, Fronius, SMA, ExelTech**
- **Racks from Unirac, Two Seas and Direct Power**
- **Batteries, Wind Generators and Thermal Collectors**
- **Pumps- Submersible and Surface**

Serving the renewable energy market since 1983

Featuring Exceptional Customer Service and Technical Expertise

www.dankoffsolar.com



Call 888-396-6611 for Qualified Dealer Near You.



Case #48:
Looking for Great
Customer Service?
Call SunWize!

We're the people that make it happen for your business. Same day shipping. Three fully stocked warehouses. Unequaled customer service. Prepackaged systems. Technical support. Jean Shappell of Northwest Energy Storage says, "I was really excited to find a company with integrity to go the extra mile to ensure competitive prices and on-time delivery." Call us at 800.817.6527 and find out how SunWize can help your business. Be successful, choose SunWize!

www.sunwize.com

Reliable People . . . Reliable Products . . . Reliable Power!



SunWize[®]



BACKWOODS Solar Electric Systems

For an earth restored and a world at peace.
Solar • Wind • Hydro

Specializing in Independent Electric Power for the Remote Home where utility power is not available. For 26 years, your questions have been personally answered by the good folks at Backwoods Solar that use these products everyday. Our catalog / planning guide teaches the basics of installing solar, wind and hydro electric residential power and we offer free system design service either by telephone, email, or your visit to Backwoods. We can also refer you to solar helpers around the country.

**185 PAGE
CATALOG / PLANNING GUIDE
Free to Home Power readers
in the U.S.A.**

Visit us or write:
Backwoods Solar Electric Systems,
1589-HP Rapid Lightning Creek Rd,
Sandpoint, Idaho 83864 USA

Phone: (208) 263-4290 • Fax only (208) 265-4788

Website: www.backwoodssolar.com • Email: info@backwoodssolar.com

No Power? No Problem!

There is more to a working renewable energy system than a cheap deal on a pile of hardware.

We Provide:

Complete service. We do solar, wind, microhydro and pumping systems. Load analysis, site survey, system design, sales, installation, user training, and tech support long after the warranties expire. We live on renewable energy, have 20 years of experience, and have established over 500 systems. We specialize in NEC® compliant, safe systems that will make your Electrical Inspector smile!

Equipment for DIY. We offer reasonable deals and technical reality checks. Why settle for a packaged system when you can have yours custom designed by an expert?

Your best resource is a local pro. Tap into our network of qualified, competent Electron Connection associates across the country.

Going into the Biz? Why talk to a "sales technician" when you can talk to an electrician? We KNOW what works and how it works. We offer technical support, system design help, prompt shipment, fair pricing and NO BULL. Local referrals always. Electrical competence required.

Electron Connection

Bob-O Schultze
CA Electrical Lic #613554
OR CCB Lic #149724



800-945-7587

 toll free

www.electronconnection.com

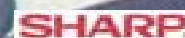
 online catalog

PO Box 203, Hornbrook, CA 96044 USA

Voice / Fax: 530-475-3401 • E-mail: bob-o@electronconnection.com

FROM THE GROUND UP

My RE System Design Choices

Linda Pinkham

©2005 Linda Pinkham

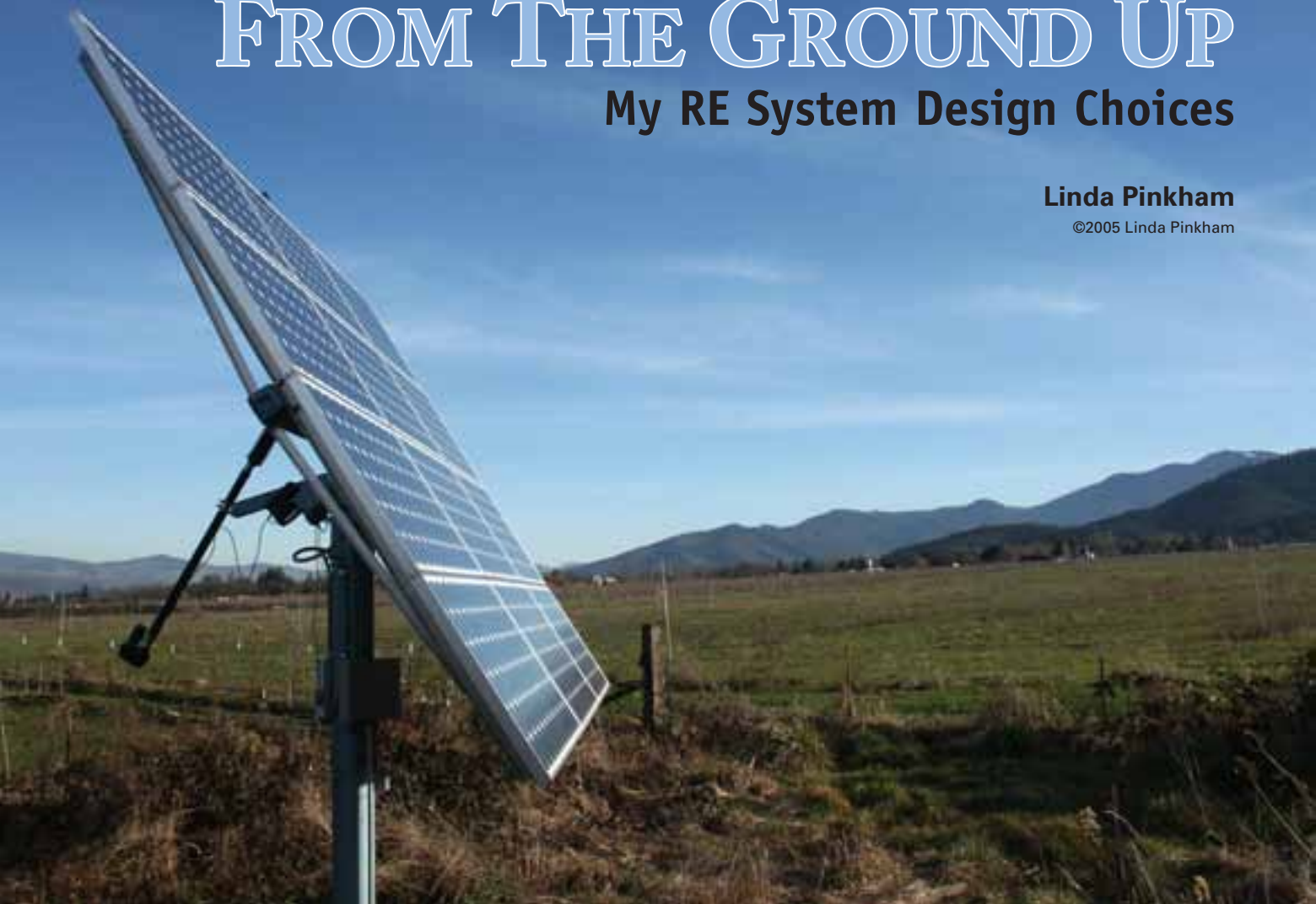

Sunny pastures—a 2.1 kilowatt solar-electric array powers the Pinkham residence.

“The best way to learn about renewable energy is to live with it,” recommends Richard Perez, publisher of *Home Power* (HP). I started thinking about how to change my household over to renewable energy (RE) soon after I joined the HP crew. I wanted to not only talk about saving the planet, but also contribute to the future of it by doing something personally—walking the talk.

Of course, the first step, when considering any RE project, is to look at ways to save energy, since it costs much less to save watt-hours than to produce them. If you’re planning to use the sun to generate electricity, every dollar you spend on more efficient appliances will save you roughly three to five dollars in equipment cost.

During the course of a year, I worked on energy efficiency in our home by changing to compact fluorescent bulbs, turning off lights and appliances when no one was using them, using cold water for laundry, turning the water heater down to 120°F (49°C), and putting phantom loads, such as the computer and TV, on plug strips. I managed to reduce our electricity bill by nearly half, getting our

energy use down to an average of 13 to 20 kilowatt-hours (KWH) per day, depending on the season. That’s not bad for a household reliant on electricity for cooking, water pumping, and hot water, and using a forced-air oil furnace with a huge blower motor for heating.

What Kind of RE System?

My home is located on 4 acres of flat farmland on the outskirts of Medford, Oregon. My husband Daniel was intrigued by the quiet and graceful African Wind Power wind generator. But a realistic look at the wind resource and the expense and labor for erecting a wind turbine revealed that this was not the best choice, even though we have plenty of room for a tilt-up tower. With no running water except for seasonal flood irrigation, microhydro was not an option.

Clearly, the best resource for our home is sunshine. While many consider Oregon to be a notoriously rainy state, most of it, including the southern reaches where I live, has almost as much solar potential as Florida. Medford is situated in the sun belt of the state, with 4.9 average daily

peak sun hours. Choosing a solar-electric array as our RE generating source was a natural, but where would we put it?

Finding the Perfect Site

The three most common mounting options for a solar-electric array are:

- Roof mount
- Ground mount
- Pole mount

The amount of south-facing roof that we have is very limited. Knowing that we would eventually put in a solar hot water system, we decided not to use the roof space, which is just big enough for a single, 4 by 8 foot, flat-plate collector.

A ground or pole mount can go just about anywhere that you can find a spot with full sun. Most of the sunniest places on our property are in pasture areas where the grass is chest high for much of the year. So we decided that the best option for us would be a pole mount, which would get the photovoltaic (PV) modules up above any high grass.

On the south end of the property, we have a wide-open solar window, with no trees or obstructions to cause shading. Just to make sure, we used a Solar Pathfinder to check. The Pathfinder indicated that if Daniel trimmed the hedge on the west border of our property from an unruly 12-foot height to 6 feet, there would be almost no shading during any time of the year. Since we are in a rural area with plenty of room, a pole-mounted system would not raise any objections from the neighbors—mostly pear trees, cows, and horses.

The Solar Pathfinder shows a wide-open solar window.



Solar array disconnect, system AC kilowatt-hour meter, and inverter disconnect mounted over a weatherproof wiring enclosure.

To Track or Not to Track?

Our wide-open solar window, on top of good insolation (amount of solar energy striking a given area over time) and the fact that our system would be grid-tied, called for using a tracking mount. We chose a dual-axis tracker manufactured by Wattsun. It follows the sun’s azimuth (direction) and altitude throughout the day, keeping the PV modules at a 90-degree angle to the sun. A tracker can increase production by 45 percent under ideal conditions. For our region, the average daily peak sun hours increase from 4.9 to 6.7 when a dual-axis tracker is used, compared to mounting the PVs at a fixed 42-degree angle (our latitude).

The downside of trackers is that they can only do all this if they are working. Like any piece of mechanical equipment, trackers may require maintenance or repair. But since we are near town, and Wattsun has a stellar record for reliable and prompt service, any needed repairs will not create a huge inconvenience. Our tracker has been operating for more than a year without a hitch.

Who Needs Batteries?

Our home is located on the grid. While we share as much love for our local utility (PacifiCorp) as anyone, it just doesn’t make sense for us to have a stand-alone system independent of the utility grid when it costs only US\$0.06 per KWH to purchase electricity from the utility. A stand-alone system regularly loses energy because of regulation by the charge controller when the batteries are full, and usually requires an engine generator for backup. If the site has utility electricity, a grid-tied system has no regulation losses—excess energy is absorbed by the utility, and there’s little need for a generator.



Home Power technical editor Joe Schwartz keeps his hands dirty.

A stand-alone battery bank would cost at least US\$2,000. I like my modern conveniences too much, and with a house that's already dependent on electricity for most of its main functions, an autonomous system would be both cost-prohibitive and complicated. So a grid-intertie system was the choice.

The next big decision was whether to have battery backup. In the twelve years that we've lived here, the electricity grid has been down only a couple of times for more than four to six hours, and has never been down for more than twelve hours that I know of. Having several large batteries that would require occasional replacement in exchange for a dozen hours of survival independence over a dozen years just doesn't pencil out. I spend days at a time out in the woods camping, and my only electrical gadget is an LED flashlight. In the event of a utility outage, I could probably manage admirably well in my house with the exact same gear.

How Big?

Sizing a system for batteryless grid-intertie is not a monumental task. Instead of running around with a pencil and clipboard and a meter hanging off your belt to figure out how much electricity your appliances use, you only need to find your latest electricity bill. Our Pacific Power bill shows total KWH used each month, the average per day, and a comparison graph for every month in the past year. In addition to historical use, a few other factors figure into the equation for how big a system to put in.

Percentage of utility offset. A little quick math showed that we use approximately 6,500 KWH each year to run our home, or an average of 17.8 KWH each day. Our goal was to offset 100 percent of our utility use. But you could just as easily decide to offset only a portion, for example, 50 percent of your utility use.

Incentives. The generous incentives offered by the Energy Trust of Oregon and Oregon's state tax credit of US\$1,500 were major deciding factors for us to strive for 100 percent utility offset. These incentives would pay nearly 50 percent of the installed system costs, so it took little deliberation to decide to install the maximum size system we would need and could afford.

Net metering agreement. The next factor in deciding on how we should size our system had to do with what sort of net metering agreement was being offered by the utility. I requested a contract and they sent me one that offered annual net metering, which meant that we could use our excess production in the summer, when the days are long and always sunny, to offset our winter use, which is higher due to the short, cold days, and often inclement weather. The only obvious catch in the contract was that any excess production beyond our annual use is given to the utility. (There were other catches, too—see the "Double-Dealing Utility" sidebar.)

So for us, the ideal system would be sized to produce exactly what we would use each year, with little excess that would have to be forfeited. We also needed to take into account the future solar hot water system. That could offset anywhere from 25 to 33 percent of our electricity use. We estimated low, since there are just the two of us, and we don't use a lot of hot water. So we would need a PV system that could produce 4,500 to 5,000 KWH AC per year at our site, or about 12 to 13 KWH per day on average.

PWATTS Calculator Results

Month	Energy Production (KWH)	
	42.3° Fixed Tilt	2-Axis Tracking
January	155	177
February	214	251
March	272	331
April	305	418
May	335	481
June	334	548
July	379	619
August	385	570
September	344	469
October	300	373
November	140	160
December	125	140
Annual Total	3,288	4,537



Joe and Daniel put the finishing touches on the tracked PV array.

Calculations. Calculating the number of PV watts you need can be figured out mathematically, using average daily insolation figures that take into account different types of PV mounts. Solar Energy International's *Photovoltaics Design and Installation Manual* or *Home Power's* CD-ROMs are handy places to find that information. You can also download the data directly from the National Renewable Energy Lab's (NREL) Web site (see Access). The math is simple—divide the average daily KWH usage by the average daily peak sun hour figure for your site. Multiply by 1.25 for an overall batteryless PV system efficiency of 75 percent. For our site with a dual-axis tracker, the equation determined that a 2 KW array would be about right.

The above calculation will give you a pretty good estimate of how much PV you need. For more detailed estimates, you can go to a very helpful Web site with a calculator, called PVWATTS (see Access). It allows you to plug in the size of the array and its type of mounting system, and calculates your projected annual production for the location you select on a U.S. map. It breaks the production into months, so you can really predict what your system will likely produce from month to month. And you can play with the configuration of the system to see the difference between the production that results from using different PV mounting systems in your location. For example, you can figure out how much more production a dual-axis tracker will yield over a fixed mount with the angle set at latitude (see table).

Picking the Gear

Once we knew what the overall plan was, it was time to move on to selecting gear. The options change on a regular basis in this ever-expanding and growing marketplace. But with the system design parameters figured out, the pieces started falling into place.

PV modules. When we selected components for our system, Sharp PV modules were flooding the market. They were plentiful and relatively inexpensive. I'm not a PV connoisseur, and I couldn't tell you what the substantial differences are between any of the leading models on the market. But I liked the fact that Sharp had just come out with a reasonably priced, 175-watt single-crystalline module (this model has since been replaced with a 185-watt module of the same size) with a 25-year warranty. I also liked the idea of their quick-connecting MC cables, which would make the wiring go that much faster.

Tracker. We chose the Wattsun dual-axis tracker because we wanted a tracker that would be wide-awake first thing in the morning, ready to go, unlike passive trackers. I liked the Wattsun trackers from the first time I encountered one while sleeping outside at the home and office of *Home Power* publishers Richard and Karen Perez. I was gently awakened at dawn by the techie sound of the tracker seeking the first rays of sunlight.

People debate a great deal about whether to track or not, but I would choose a tracker just for the sheer fun of watching the array follow the sun across the sky like a flower. An added benefit of course, is the additional production, which the PVWATTS calculator shows as 1,249 KWH more per year for our site—28 percent more than a fixed array.

Linda shows off her solar-powered mains panel.



The Double-Dealing Utility

When we signed our contract with the utility, we were impressed that our local company had offered one of the best contracts that could exist in the realm of net metering. The contract was classic annual net billing, which would allow us to size our system for our average annual use. Even though this is what the net metering legislation in Oregon had originally specified, the generosity of the contract was surprising to us, since our impression of Pacific Power over years of dealing with them was that they were a typical large corporation that cared only for its bottom line.

It turns out that we were impressed too soon. Mom always said that you can't change the spots on a leopard, and this was no different. The first month we showed a credit balance of KWH (excess generation), the credit appeared as a monetary amount on our bill at US\$0.0422 per KWH. However, when we purchase electricity, it costs us US\$0.066 per KWH.

The credits, according to our contract, were to be carried forward at their full value to offset our future use. Not so, says the utility. Instead, our goal of zeroing out our electric bill may be out of reach now, pending how the Oregon Public Utility Commission (PUC) resolves the legal problem of the utility having entered into a contract that it doesn't wish to honor.

It seems a bit disingenuous to offer one contract when someone is making critical decisions involving thousands of dollars in expenses, and then change the terms after the expenditures have been made. Had we known, we could have configured our system in a number of different ways to make the utility's latest contract offer more advantageous to us, for example a wind/PV hybrid system that might allow us to even out production from month to month, or a battery-based system and time-of-use metering that could help us sell back to the utility at a higher rate.

Apparently, by the time Oregon's net metering legislation was interpreted and negotiated between PacifiCorp and the PUC, the intent of the law, as originally written, had been subverted. We'll let you know how it turns out, as we take our complaint before the PUC. Meanwhile, if anyone has some interesting utility double-dealings you'd like to let us know about, please send us your stories.

Our tracker could be powered by an AC branch circuit directly from our grid service. With the largest model of Wattsun's tracker (the AZ-225), we could fit twelve of the Sharp, 175-watt modules on it for a 2.1 KW (STC) array—perfect.

Inverter. At the time we chose our system components, only a couple of choices were on the market for small residential grid-intertie. Glowing reports from the field about SMA's Sunny Boy line of products impressed us. We chose the Sunny Boy 1800U model, which can handle up to 2,200 watts of PV input, according to the technical manual. So far, the Sunny Boy has performed as anticipated without skipping a beat.

These days, there are more choices and lots of different price breaks. You'll have to shop around for your equipment to figure out the features you want, but choose an inverter with an excellent track record in the field as your first criteria.

Time to Walk the Talk

Making choices about what sort of RE system to purchase is rarely an arbitrary decision. System designs are usually based on:

- Resources available
- Goals of the system owner
- Available equipment
- Cost

Other factors, such as incentives or utility net metering agreements, also influence decision-making. Overall, the choices are straightforward, and driven by the parameters of your particular site and your preferences. Planning is easy with the right preparation and proper analysis of your site. Installing the system adds another dimension that involves a much deeper involvement in the technology.

You can either learn how to install your own RE system, or you can seek the help of a qualified professional. In our case, we hired Bob-O Schultze of Electron Connection, and enlisted the help of Joe Schwartz, *HP's* CEO and technical

The Pinkhams chose a Sunny Boy inverter for their grid-tied system.





The Wattsun tracker makes the most of a typical southern Oregon sunny day.

editor, and also a licensed RE installer in Oregon, to install the system.

Whether you decide to do it yourself, or get help, the best preparation is to understand the basic choices you need to make and how to go about making them. So, what are your goals? What does your site offer? What incentives are available in your neighborhood? Find out and you will be well on your way to walking the talk. What are you waiting for?

Access

Linda Pinkham, c/o Home Power magazine, PO Box 520, Ashland, OR 97520 • linda.pinkham@homepower.com

Array Technologies Inc., 3312 Stanford NE, Albuquerque, NM 87107 • 505-881-7567 • Fax: 505-881-7572 • sales@wattsun.com • www.wattsun.com • Wattsun PV tracker

Electron Connection, PO Box 203, Hornbrook, CA 96044 • 800-945-7587 or Phone/Fax: 530-475-3401 • bob-o@electronconnection.com • www.electronconnection.com • Installation

Sharp Electronics, Solar Systems Division, 5901 Bolsa Ave., Huntington Beach, CA 92647 • 800-SOLAR06 or 714-903-4600 • Fax: 714-903-4858 • sharpsolar@sharpsec.com • www.sharp-usa.com/solar • PVs

SMA America Inc., 12438 Loma Rica Dr. Unit C, Grass Valley, CA 95945 • 530-273-4895 • Fax: 530-274-7271 • info@sma-america.com • www.sma-america.com • Inverter

Solar Pathfinder, Route 1, Box 260-1, Linden, TN 37096 • 317-501-2529 • Fax: 931-589-5400 • info@solarpathfinder.com • www.solarpathfinder.com • Solar Pathfinder

National Renewable Energy Laboratory (NREL) • <http://rredc.nrel.gov/solar/pubs/redbook> • Solar insolation data • <http://rredc.nrel.gov/solar/calculators/PVWATTS> • PVWATTS calculator



Solar Water Heater
Evacuated Tube Technology
BTF Ltd.
POB 409 Fennville MI 49408 USA
Tel. 269-236-6179 info@btf solar.com
www.btf solar.com

Coupon
Copy this Ad. and mail with your order form for 15% discount. Offer expires June 21, 2005

The BEST Tool for Solar Site Analysis

Easy to Use Ingenious design projects your horizon onto a sun chart for the full year. Perfect for optimal siting of:

- Photovoltaic Arrays
- Solar Hot Water Systems
- Solar Homes
- Greenhouses
- Gardens

Includes sun paths from 0–66° North & 0–49° South. With metal case & tripod \$255, Handheld \$175, (+S&H).

Fast & Accurate

Rt 1 Box 260-1, Linden, TN 37096
317 501-2529
info@solarpathfinder.com • Fax 931-589-5400

Solar Pathfinder
FAST ACCURATE SOLAR SITE ANALYSIS
www.solarpathfinder.com



WATTSUN™
SOLAR TRACKERS

- A diverse line of quality trackers for: Grid-Intertie, Commercial Applications, Remote Homes and Water Pumping.
- Trackers from 150 W to 15 kW.
- Complete pre-engineered TracKits™ available.
- Patented technology.
- 15 years of solar tracking experience.

Array Technologies, Inc
505-881-7567 www.wattsun.com

SOL-RELIANT™ *The Solar Water Heater Built To Last*



No freezing!
No overheating!
No phantom loads!
No parasitic losses!
No visible plumbing!

- Solar-powered pump.
- Design life: over 25 years.
- OG-300 and Bright Way certified.
- Easy to install and reinstall after reroofing.
- Dealer inquiries welcome.

Tax credits and rebates in some states pay up to half the cost!

Call (888) SOL-RELY

www.SolReliant.com

You'll Flip When You See Our Prices

SUNELEC.COM Super Spring Liquidation Sale



S U N E L E C T R O N I C S

INTERNATIONAL, INC.

Tel: (305) 536-9917 / Fax (305) 371-2353 / E-mail: info@sunelec.com / Web: www.sunelec.com

Not all batteries are created equal!

Rolls ... better by design!

- Modular dual container construction
- Unsurpassed cycling - North America's best
- Widest range of specifications available
- Industry's largest liquid reserve
- 10 year warranty - 15 year average life

Serving renewable energy customers since 1984.

Rolls

BATTERY ENGINEERING

1-800-681-9914

sales@rollsbattery.com • www.rollsbattery.com



Surrette Battery Company Ltd.



SOLAR CONVERTERS INC.

We design and manufacture Power Control Solutions for your Renewable Energy Systems!



Linear Current Boosters

Increases Solar Pump Performance

- 12 / 24 V @ 7 amps
- MPPT
- Voltage Limited
- Fused Output



DC Autotransformers

Bi-Directional DC-DC Converter

- Battery Balancer / Equalizer
- Converts Battery Power to Different Voltages
- Up / Down Converter



Battery Desulphators

Extends Battery Life

- Recovers Sulphated Batteries
- Single unit 12 to 48 V
- Adjustable Pulse Strength



Linear Voltage Boosters

Keeps a Constant Battery Voltage to your Equipment

- Charge a Battery from a Lower Voltage Battery or PV
- Water Pump Booster and Controller



Generator Starters

Starts / Stops Generators based on Battery Charge

- Single unit 12 to 48 V
- Controls any Generator
- Temp. Compensated

ALSO...

- MPPT Power Tracker™ Charge Controllers
- Cathodic Protection Controllers
- Voltage Controlled Switches
- Solar Lighting Controllers

Please visit www.solarconverters.com for MORE products and details

C1-199 Victoria Road S., Guelph, ON, N1E 6T9, Canada Phone: 519-824-5272 Fax: 519-823-0325 E-mail: info@solarconverters.com

Ram Pump Reprise

Reviving Gold Rush Technology in Alaska

If I hadn't recently been to a workshop on hydraulic rams at the Midwest Renewable Energy Fair, the pear-shaped cast iron bell rusting away behind the main lodge at Chena Hot Springs Resort might have escaped my notice altogether. It was tucked away anonymously amidst a small cache of relics from Alaska's gold rush heritage, overshadowed by far larger sluices and dredge buckets, whose hydraulic past was much easier to discern.

Gwen Holdmann

©2005 Gwen Holdmann



Being somewhat equally fascinated by history and hydropower, I was curious to learn if the pump had actually been used at Chena Hot Springs Resort, where I work as vice president of new development. I started by asking the current resort owner, Bernie Karl, about the origins of the ram. To his knowledge, its existence on the property stretched back as long as his tenure did, but he didn't know anything about how it had been used or why it had ended up sitting behind the lodge. Browsing through the many historical pictures from the resort didn't help either; I could see no apparent sign of a water ram or penstock in any image.



The supply tank situated in the creek, with the geothermal well house and storage tank in the background.

Historical Sleuthing

I took a closer look at the ram pump itself. It was in rough shape, and the impetus (or waste) valve was broken off. I peered inside the manifold, and saw the telltale white, calcium carbonate scaling that anyone who has worked around a hot spring for long is familiar with. Calcium carbonate precipitates out of the hot water as it cools, such as it does while flowing any distance through a pipe. Since no other hot springs are in the near vicinity, this gave me

the clue I needed to be fairly certain that the pump had been used on site. In addition, I suddenly had a pretty good idea of what its original purpose may have been.

Chena Hot Springs is an oasis tucked into Monument Valley, amidst granite spires rising out of the rolling, hilly landscape of interior Alaska. Today it is accessed via Chena

System Overview

The water enters an artificially formed settling pool just behind a small dam (about 1 foot; 0.3 m high) and enters the screened inlet basket. The supply pipe comes out of this basket well below the water surface, and is buried in the creek bed for a distance of 20 feet (6 m). The 4-inch diameter supply pipe continues 500 feet (150 m) to the supply tank, and then enters a 2-inch steel pipe that goes directly to the water ram.

The ram is 40 feet (12 m) from the supply tank, on the bank of the creek. The water enters the ram, excess water is returned to the creek, and the remaining 15 percent is pumped through a plate heat exchanger (the heat exchanger has artesian geothermal fluid feeding it from the well at 12 gpm). This increases the water temperature by 50°F (28°C), and then the water is pumped up 25 feet (7.6 m) to a storage tank.

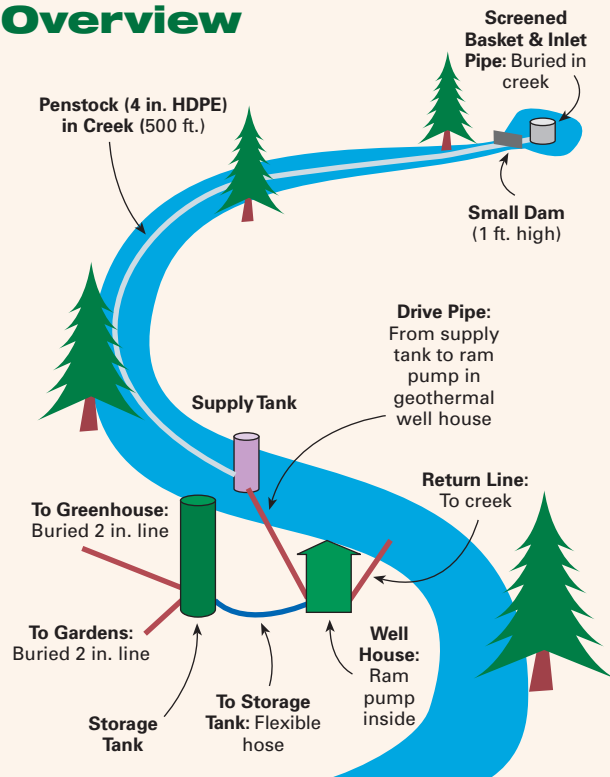

Ram Pump Basics

With a background in mechanical engineering, I have a real fascination for ram pumps. With no other visible energy inputs, they can appear to be perpetual motion machines until you understand what is going on below the surface. Their simplicity of design is genius, and they are real mechanical works of art. These pumps deliver water continually with no electricity or other added energy, and very minimal maintenance.

A ram pump uses the downhill flow of water to pump a portion of it uphill. You can pump up to 25 percent of your supply water, depending on the drop and the lift. Ram pumps will work on sites with 3 to 50 feet (0.9–15 m) of head (vertical drop) and can deliver to elevated sites far from the pump and source.

Ram pumps are quite efficient for a mechanical pump—more than 75 percent in many cases. Efficiency is calculated by multiplying the amount of water delivered by the delivery height, and then dividing by the amount of water consumed times the input head. And with enough head and flow, ram pumps can deliver thousands of gallons per day up to 500 feet above the pump site. The output of a ram pump system can be estimated by this formula:

Water Delivered = Available Water x Source Fall x 0.5 ÷ Delivery Height

The price range for a new pump is US\$250 to \$1,700, depending on size, materials used, and durability. When including steel drive pipe, metal ball valves, and other quality components, the price can appear high. But you will end up with a system that will last for decades. Some of the less expensive pumps are plastic, and designed to work at low head and flow. They are not able to take the incessant beating of the “hammer effect” that many ram pump installations will dole out to the pump and drive pipe fittings.

Five different ram pump sizes are available from Rife Hydraulic Engine Manufacturing Company. Other excellent pumps are on the market, including Folk brand ram pumps, which have a slightly different design, and use durable, space-age materials in the valves. (See *HP40* for a Folk ram pump installation article.)

A ram pump usually involves more work to set up than a motorized pump, but is extremely reliable and tough. I’m pretty sure they will outlast any electric pump you would choose to compare them to, and a solar-direct-powered pump could never match their 24-hour-a-day availability.



Ram pumps, old and new.

Hot Springs Road, a well-maintained, year-round road that ends at the resort, 60 miles (97 km) northeast of Fairbanks, Alaska. However, when Chena Hot Springs was discovered by prospectors from Fairbanks in 1905, it took them well over a week to reach what was then a very remote location. What they found, by following steam rising over the hillside, was a geothermal anomaly consisting of sixteen hot springs confined to a narrow stretch along the bed of tiny Spring Creek.

Once word of the discovery of hot springs in the Fairbanks vicinity spread, a clientele developed quickly and facilities were constructed. The original discoverers built a series of pools directly into the creek bed to contain the upwelling hot water, but they still had to contend with the cold water continually flowing down from Spring Creek at a much higher flow rate than the hot springs were producing. Eventually, they must have looked for a way to separate the hot water from the cold water, and maybe even pump it indoors into the first primitive lodge built there. This is likely where the ram pump came into play.

Spring Creek has a very consistent drop along its length, with approximately 1 foot (0.3 m) of drop for every 50 feet (15 m) of distance. It would have been a relatively simple matter to use this head to operate a water ram for pumping the hot water directly from the springs to use for bathing. And there are certainly descriptions detailing the pleasures of such hot water being pumped into the lodge for use by guests. Later proprietors of the resort came up with a far less elegant solution to accessing the hot springs—they simply used heavy equipment to reroute the creek and expose the hot springs in a series of constructed holding ponds, which is how it still is today.

How a Ram Pump Works

All ram pumps work on the principle of momentum, which is controlled by a cycle set up by the interaction of two valves—an impetus valve and a flapper valve—in the pump.

1. When the impetus (aka “waste”) valve is opened (this must initially be done by hand to start the pump cycling), water begins to flow down the drive pipe and through the impetus valve as in Figure 1.
2. The drive water velocity increases until water friction slams the impetus valve shut, as in Figure 2. The momentum of the water forces open the flapper valve and pushes water past it to pressurize the air chamber above the water level.
3. In Figure 3, the water pressure above the flapper valve overcomes the spent momentum below it, forcing the flapper closed again. The water that made it past the flapper in Figure 2 is then forced by the extra air pressure out the delivery pipe and up to the delivery point.
4. Since the momentum of the water coming down the drive pipe was spent, the pressure in the impetus area momentarily decreases to zero, the impetus valve falls open, allowing water to flow down the drive pipe again as in Figure 4 (just like Figure 1), starting the cycle over again.

This process occurs over and over until something happens to stop the cycle. Ram pumps can cycle anywhere from 25 to 300 times per minute. The

frequency of the cycle is adjustable by changing the length of the stroke of the impetus valve. A longer stroke produces a lower frequency. Weight added to or subtracted from an impetus valve, and even springs, have been used to adjust the frequency. Lower frequency means more of the supply flows to and through the pump and more is pumped up the delivery pipe.

The stroke is adjusted to restrict the amount of water used to the amount available from the source, or if the supply is unlimited, to regulate the amount delivered to match the amount needed.

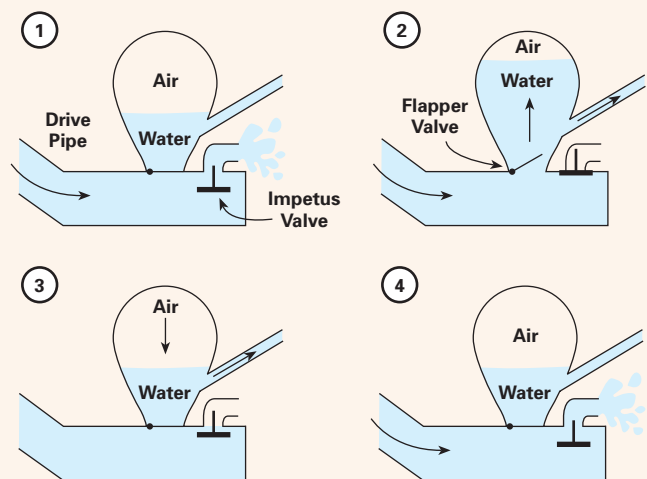

Gwen at the dam site, with the partially buried stainless steel inlet.



New Challenges

Although accessing the hot water is no longer a problem at the resort, a new challenge arose during the summer of 2004. The owners of Chena Hot Springs Resort mandated that we convert to 100 percent renewable energy (RE) to power the resort by the end of 2005, and in the process become a working showcase for RE and sustainable development for Alaskans. I was put in charge of this ambitious project. My three primary responsibilities were to:

- Create a renewable energy center
- Start an organic garden and a production greenhouse (geothermally heated, of course)
- Organize the construction of a 400 KW geothermal power plant to provide a primary energy source for the resort

Finding the water ram gave me an idea that could combine all three of these projects. Geothermal water is great for bathing humans, but not so great for watering plants. While our geothermal water actually meets drinking



Gwen Holdmann shows off Chena Hot Springs Resort's Renewable Energy Center.

water standards for total dissolved solids (TDS), it contains slightly elevated levels of salt. We probably wouldn't notice the effects over one season, but over several years, the cumulative effect of salt leaching into our soil would cause some real problems for our fledgling gardens.

The gardens are located beyond the reach of the existing cold water plumbing system. Throughout the early part of the 2004 season, we kept our plants happy by providing water through a lengthy hose system and by hauling water in 55-gallon (210 l) barrels to the greenhouse. The ideal solution was clearly to get the water from Spring Creek, which is adjacent to all the garden areas. But this had two disadvantages. The water close to the hot springs was mixed with the high sodium content geothermal water, and the water we could collect further upstream from the springs was a frigid 38°F (3°C).

Chena Hot Springs Resort Ram Pump

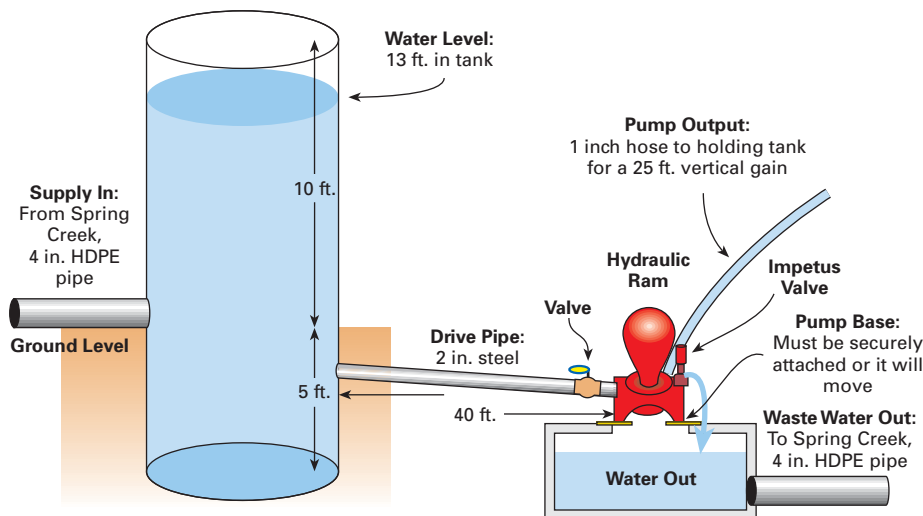

Installation

To overcome both problems at once, we installed a small dam and built an inlet using a recycled 4-foot (1.2 m) diameter stainless steel basket, which we buried 3 feet (0.9 m) into the creek bed to use as the intake screen for the system. This inlet system was installed approximately 500 feet (150 m) upstream from the main hot springs area, and well above the zone where the hot water is discharged into the creek. For a penstock, we installed 4-inch-diameter HDPE pipe, which is heat-welded together.

We pulled the pipe sections directly down the creek bed by using a walk-behind trencher, so we would disturb the vegetation along the creek banks as little as possible. Once we had installed enough sections to provide plenty of head (vertical drop) to operate the ram, we connected the penstock to the base of a water tank installed directly into the creek bed. It's not generally recommended to install pipelines in creeks because of floodwater debris. But this creek is not fed by runoff. It is 90 percent spring fed, and has extremely consistent flow year-round—definitely not prone to flooding.

We assembled the supply tank ourselves out of a recycled 56-inch diameter, 15-foot-long (4.6 m) pipe, which we welded a steel base onto. This tank was buried approximately 5 feet (1.5 m) into the creek bed, and was designed to act essentially like a giant elbow in the system to reduce friction loss.

The penstock delivers far more water to the tank than the water ram (which operates off about 15 gpm of flow) could ever use. However, we wanted to leave our options open to use the extra water delivered for other projects. For example, we are also installing a LH1000 hydroelectric turbine, built by Energy Systems & Design, and supplied by ABS Alaskan. The water tank allows us to access this pressure head and flow from several different locations on the tank with minimal friction loss.

Our gardener, Keegan Kuhn, provided us with the number of gallons per day of fresh water we needed for our gardens (700 gallons; 2,650 l), and we then consulted with ABS Alaskan and the Rife Hydraulic Engine Manufacturing Company to size our ram. We wanted to use a Rife ram not only because of their excellent reputation, but also because the antique ram I had found is a brand now built by Rife.

In the end, we decided to use their largest ram (#5) to pump 1,600 gallons (6,000 l) per day from 9 feet (2.7 m) of available pressure head in our storage tank to a holding tank 25 feet (7.6 m) higher. We actually used a second 56-inch-diameter pipe standing on the creek bank as our storage tank, since our supply tank had worked so well.

We had a little scare when we first filled our supply tank. The supply tank was supposed to provide the water pressure to operate the ram pump. The level of the water in the supply tank should be the same as the level of water at the inlet, or just slightly lower due to friction loss in the pipeline. But since the tank is 500 feet (150 m) downstream, and therefore downhill from the inlet, the water level in the tank should be higher than the level of the creek by the same vertical elevation difference as between the inlet and the tank.

This water “head” provides the feed to operate the ram, so having enough water head in the tank is pretty important. I had surveyed a drop of 8 feet 7 inches (2.6 m) along this section of the creek, but when we opened the valve to fill the tank, the water barely trickled in and only 2 or 3 feet (0.6–0.9 m) of water stood in our tank after 24 hours. We surmised that there must be air trapped in our penstock, and after repeatedly flushing the tank, we eventually managed to purge the penstock of air and measured the head at 9 feet (2.7 m), which exceeded our expectations.

When we installed the ram, we intended it for year-round use—quite a challenge in the extreme winter temperatures we have at the resort. But the warm ground that never freezes around the springs helps keep the buried pipelines from freezing, and we have plans for tapping one of our artesian geothermal wells upstream to keep the inlet and penstock ice free. For this winter, we chose to shut down the pump in early October during freeze-up because there wasn't anyone on site continually to baby the system and make sure nothing froze up. We removed the pump and drained all the lines, and the system is in hibernation until spring.

Pampered Plants

Chena Hot Springs' owner Bernie Karl had a small heat exchanger he wanted to install in the system. He wanted to warm the water from Spring Creek after it exited the ram pump and before it went up to the holding tank, using the artesian flow from our hot water well.

We attached a valve to our geothermal wellhead, which flows at about 550 gallons per minute with 9 feet of standing head, and allowed the hot water (165°F; 74°C) to flow out of this valve and through the heat exchanger at a relative trickle of 12 gpm. The water ram pumped the cold water through the other side of the heat exchanger at just over 1 gpm.

The gardens at Chena Hot Springs Resort.



This arrangement allowed us to heat the cold water by nearly 50°F (28°C)—to 85°F (29°C). Once it actually reached the gardens, it had cooled to 65°F (18°C), but this still made for some happy plants, according to our gardener. We did lose some flow in installing the heat exchanger, which is why we installed a Rife ram one size bigger than we otherwise would have needed.

Renewable Resort

Although the planning and layout for the system was more time-consuming than we had anticipated, the actual installation was fairly easy. Operation has been completely trouble free to date. In fact, the water ram hasn't missed a beat since the minute we started it up.

The ram pump has become a huge attraction at the resort, and nearly everyone who visits sees it as they wander about the resort property, or as part of an organized tour. It has become the showcase for our new Chena Renewable Energy Center, which opened on August 10, 2004.

The Renewable Energy Center is a joint project between Chena Hot Springs Resort and ABS Alaskan. The center highlights all types of renewable energy and also promotes conservation. We have planned a series of RE projects for the center in addition to the ram, including the LH1000 water turbine, demonstration wind- and solar-electric systems, and a 400 KW geothermal power plant. Getting back to our roots with the water ram project has been a great first step in our renewable journey.

Access

Gwen Holdmann, Chena Hot Springs Resort, PO Box 58740, Fairbanks, AK 99711 • 800-478-4681 or 907-488-1505 • Fax: 907-488-4058 • gwen@yourownpower.com • www.chenahotspings.com

Jim Norman, ABS Alaskan Inc., 2130 Van Horn Rd., Fairbanks, AK 99701 • 800-235-0689 or 907-451-7145 • Fax: 907-451-1949 • jim@absak.com • www.absak.com • Equipment supplier

Rife Hydraulic Engine Mfg. Co. Inc., PO Box 95, Nanticoke, PA 18634 • 800-RIFE-RAM or 570-740-1100 • Fax: 570-740-1101 • info@riferam.com • www.riferam.com • Ram pumps

Folk Water Powered Ram Pumps, 2770 White Court NE, Conyers, GA 30207 • 770-922-4918 • jefolk@worldnet.att.net • Ram pumps

Energy Systems & Design, PO Box 4557, Sussex, NB, Canada E4E 5L7 • 506-433-3151 • Fax: 506-433-6151 • hydropow@nbnet.nb.ca • www.microhydropower.com • Hydro turbine

Midwest Sustainable Living Fair, MREA, 7558 Deer Rd. Custer, WI 54423 • 715-592-6595 • Fax: 715-592-6596 • info@the-mrea.org • www.the-mrea.org • Water powered pumping workshops



Save Up to 30 Gallons of Water With Each Load of Laundry!



**Only Top Load Horizontal-Axis Washer
Made in the USA--Great for Off-Grid Systems!**

- Avg. of 15 gallons of water & 1 oz. soap per load (great for wells & septic systems)
- Stainless steel inner & outer tubs
- Dual, re-greasable bearings on front & rear
- No front rubber gasket to worry about leakage or mildew
- Total front access to parts--*most simple design on the market*
- Simple, mechanical switches--no expensive electronic buttons!
- High extraction spin speed
- MADE IN THE USA!



Call 1-800-848-6200 to learn more!

www.staber.com

Staber Industries, Inc. 4800 Homer Ohio Ln Groveport, OH 43125



"SOLAR WAND"

SOLAR ASSISTED HOT WATER

Closed Loop Antifreeze System



"Solar Makes Dollars and Sense"
Energy - Savings Pay For System
Employment - Create American Jobs
Environment - Reduce CO₂ Emissions

Straight Forward Installation, Single Pump,
 40 Sq.Ft. of Solar Collectors, Either ACR Fireball
 2001, Double Glazed/Selective Absorber (Shown)
 or Thermomax Evacuated Tubes (Not Shown).
 Kits Including Anti-Scald Valve From \$2,700

www.butlersunsolutions.com



"Solar Wand"
 Double-walled
 heat exchanger
 screws into
 your tank

**OG-300
 Certified**

858-259-8895

***Patents Pending**

SOLAR ELECTRICAL SYSTEMS

- **\$2.25 per watt 1 kw +**
- **Single crystal, UL, M55 and SQ80 watt name brand modules**
- **5-10 years old with factory warranties**
- **4' x 4' pallet holds up to 50 units**
- **See spec sheets on our website**



Shipping and handling additional
per zip code and quantity

(805) 497-9808

solarelectricalsystems.com

SOLAR ELECTRICAL SYSTEMS • WESTLAKE VILLAGE, CA 91362

Three Men and a Baby!

Introducing the "Water Baby"...
Another breakthrough in water powered generators.



- Brushless permanent magnet design
- Adjustable while running
- Operates with as little as 3 gpm
- 12, 24, 48 volts and higher available

ENERGY SYSTEMS & DESIGN, LTD.
www.microhydropower.com 506-433-3151

SOLAR LOG HOME FOR SALE!

Lewisburg, WV—voted one of the best small towns in the mid-Atlantic



50.1 Acres w/10 year old passive solar design & 1650 W PV system. Outstanding construction w/ceramic tile, slate, cathedral ceilings & wood interior. Splended seclusion w/7 ponds, 9 rock-free fenced pastures & woods. 2 br/2bath w/full rec. room. Outbuildings. 18 miles N. of Lewisburg. \$349,000. See photos # 04-564
www.oldsprucerealty.com

Meg Hewitt • Old Spruce Realty • Jane Scott, Broker • (304) 645-3200 • remhewitt@yahoo.com

Solar Panels • Wind Turbines • DC Lighting



ABS Alaskan, Inc.

Alternative Energy & Remote Power
2130 Van Horn, Fairbanks, AK 99701
toll free: 800-235-0689 fax: 907-451-1949

visit us online: www.absAK.com

Alaska Battery Anchorage, AK ph: 907-562-4949 fax: 907-563-4900
Distribution Center Renton, WA ph: 425-251-5745 fax: 425-251-5748

Micro Hydro • Complete Systems • & More

You Say You Want a Revolution? We'll Show You How.



Women's
Basic PV/PV
Site Assessor
April 23-24
Monroe, WI

Large-Scale
Residential
Wind Install
May 1-7
Stockbridge, WI

Solar Water
Site Assessor
Training
May 20-21
Custer, WI

Wind System
Repair &
Maintenance
July 13-16
Custer, WI



We all want to change the world. Call or click for more information.

Midwest Renewable Energy Association 7558 Deer Road Custer, WI 54423 phone (715) 592-6595 fax (715) 592-6596 info@the-mrea.org www.the-mrea.org

Make a Solar Fountain!

Hal Aronson & Tor Allen

©2005 Hal Aronson & Tor Allen



Hal Aronson testing various pumps with a group of teachers at a workshop.

Building solar-powered water fountains is the most popular workshop the Solar Schoolhouse program offers. This day-long workshop is one of our efforts to foster energy literacy among teachers and students. We also provide solar energy curricula, solar technology kits for hands-on learning, and professional development workshops for teachers. This article will help you learn how to build your own solar fountain, so you can get in on the fun and education.

Solar-powered fountains are wonderful additions to schools for many reasons. They are an excellent hands-

on solar project for teachers, students, and parents. Solar fountains add a beautiful feature to school campuses and demonstrate solar electricity to students and campus visitors. Fountains are relatively inexpensive, and when kept at lower voltages, quite safe. The fact that they are solar powered simplifies the installation because it does not require a connection to the school's electrical wiring.

Solar-powered fountains respond quickly to sunlight. Students and teachers immediately see, hear, and touch the effect of the solar-electric (photovoltaic, PV) panel as it moves the water. If the mount for the panel can swivel, students can experiment. As the panel is aimed more toward the sun, the pump moves the water more vigorously. A student casting a shadow on the panel will slow or stop the water flow. This is perhaps the most effective demonstration of the relationship solar-electric panels have with the sun.

How to Build a Solar-Powered Fountain

Building a solar fountain—from design concept to completed installation—can take less than two days. We'll go through the steps, and you can apply them to your own project.

Step one—design. Pull together a concept of the fountain you want. While the design can unfold during the building process, it is useful to have a starting concept. This will aid in choosing equipment for the installation, especially the pump, solar-electric module, and basin or pond liner material. Do you want a trickling meditation pond, a 6-foot (1.8 m) tall gusher, a cascading creek, a pond aerator, a waterfall, or a bell-shaped spray? All of these features can be

Students enjoying a fountain/creek system that they helped build at an elementary school.



created using solar electricity. PV-direct, batteryless systems will only operate when the sun is shining, but batteries can be added to the system if desired.

Step two—choose the pump. Once you have a preliminary concept, you will be able to estimate how much water you want to move (volume) and how high you want to lift the water (“lift” or “head”). Volume, measured in gallons per minute (gpm), and lift, measured in feet, will help you select the water pump.

A meditative trickle can be achieved with a 1 to 2 gpm pump. To create a dynamic fountain, aim for 4 to 6 gpm. To create a cascading stream, 8 to 16 gpm will be needed. But don’t design based on our numbers alone—check with your pump supplier and test it out for yourself. Run a garden hose at the flow you want. Place the hose into a gallon container and time how long it takes to fill it. If, for example,

it fills in 10 seconds, you will want a pump that moves 6 gallons a minute.

Pump specifications will state the lift (or head) of the pump in feet and the volume of water it will move in gallons per minute or gallons per hour. Lifting water requires energy. With a given pump, the higher you lift the water, the less volume it will move. For example, the Attwood V500 will pump 5.5 gpm at 1 foot (0.3 m) and 2.8 gpm at 5 feet (1.5 m).

Energy is also required to move water horizontally through a pipe: As a rough guide, consider 10 feet (3 m) of horizontal pumping to be equivalent to about 1 foot of lift in 1/2-inch pipe. The specifications in the pump literature typically assume that a 12-volt pump is running at 12 to 13.6 volts. Wired directly to many solar-electric modules, the pump will actually run at 16 to 18 volts most of the day, which means greater pumping power. A linear current booster

Sly Park School’s Solar Fountain

At the Solar Schoolhouse Summer Institute for Educators, hosted in June 2004 by the Sly Park Environmental Education School in Pollock Pines, California, we created the fountain in reverse order. We started with a specific solar-electric module and water pump and then designed the fountain with this equipment in mind. The pump was a Rule 360 (60 gpm, 2.1 amps) and the solar-electric module was a Siemens M55 (55 watts, 3 amps). We also brought 1/2-inch copper pipe, wire, and some flexible pond liner material.

We looked on site for reusable materials. Stephen “Hoppy” Hopkins, the director of Sly Park, gave us some well-used gold panning pans, and we scavenged some old 4 by 4 posts. The length of the posts, coupled with the size of the liner we had brought, determined the maximum diameter of the pond. One participant suggested a hexagonal shape. Another laid out the hexagon and the digging began.

Because we had a fairly powerful solar-electric panel, we chose a fountain structure that lifted the water 4.5 feet (1.4 m). Using 1/2-inch copper pipe, teachers soldered together a simple structure that has a 90-degree fitting on the bottom to receive a plastic hose from the pump, and two 90-degree fittings on the top to make a “U” shape to direct the flow of the water downward.

Teachers then put the components together to give the fountain a try.

They put the pump in a bucket of water, connected the pump to the copper fountain structure with 5/8-inch ID plastic tubing, wired the solar-electric module to the pump, and aimed the module at the sun. Once we were confident in the design, we solidified the fountain structure and installed and wired the components together.

The fountain was a great learning experience, and a wonderful way to show our appreciation to the Sly Park staff by giving them a cool spot to pause and reflect. It has proven to be an interactive solar demonstration that has already engaged thousands of students.

Participants testing the Sly Park fountain plumbing before installing it in the pond.



(LCB) or controller that optimizes the power to the pump and increases water flow in low-light conditions may be appropriate in some cases—check with your pump supplier.

We strongly recommend choosing a DC (direct current) submersible water pump. Submersible pumps sit in the fountain basin, push the water, and do not need priming. DC pumps can be powered directly by a solar-electric panel. This makes a more effective solar demonstration because students observe the direct relationship between the sunlight, the PV, and the water fountain. There is no mediation (battery and/or inverter) between the PV and the fountain pump. In addition, directly wiring the PV to the pump eliminates the use of a battery, making the system simpler to install, cheaper, safer, and easier to maintain.

Several readily available pumps provide a range of pumping capacity. For inexpensive pumps, seek out marine bilge pumps (available through catalogs or at marine supply shops). They are designed for a 12-volt DC system and many of them perform well in the 9- to 18-volt DC range. This makes them well suited for solar-electric modules. A bilge pump that moves 6 gpm can be obtained for US\$15 to \$20. These pumps are quite durable and forgiving.

Step three—choose the solar-electric panel. Your solar-electric panel should be able to provide the voltage and amperage required by the pump. That said, you can intentionally underpower a pump if your goal is a more modest flow and lift of water. For example, for a meditation pond, we have powered a 2-amp Rule pump with a 20-watt (1-amp) PV module.

In some situations, you may benefit from an oversized solar-electric panel. The folks at one school wanted to power a 2-amp pump, but the area is overcast much of the time. We gave them an 80-watt (5-amp) PV module. The fountain performs beautifully, lifting the water 5 feet (1.5 m) even in



The liner is laid into the hole dug for the fountain basin and across the fountain curb. Water is added before the liner is tacked to the wooden curb to allow for an unstressed fitting.

low-light conditions. An oversized solar-electric panel will also increase the number of hours a day that the pump will be able to move the water.

Step four—assemble the components and test. It's a good idea to put together your fountain and test it before making the installation permanent. Test it in a variety of sun conditions, and make sure you're happy with the results.

Step five—dig or build a basin. The key here is to make the basin wide enough to accommodate the splash from the fountain. The basin should be deep enough to hold plenty of water to keep the fountain or stream running for a substantial amount of time without the addition of water. It should also be reasonably watertight, which can be accomplished with rigid or flexible pond lining material, bentonite clay, or concrete. Use your creativity!

Step six—site and mount the solar-electric panel. You need to ensure optimal sun for the solar-electric panel. Use a Solar Pathfinder or other solar siting device to find the sunniest location, year-round.

Once you select an appropriate site, build or buy a sturdy mount for the PV module. A simple design that allows for panel rotation has some educational advantages. Aesthetics may suggest alternative racks made from materials that might not be considered in a home solar-electric system.

Step seven—plumb the pump. The plumbing that brings the water to the fountain can be copper pipe, plastic pipe, or flexible plastic tubing. If it is made from 1/2-inch copper pipe, you will need to make a connection between the pump and the fountain tube. We recommend using

Sly Park Solar Fountain

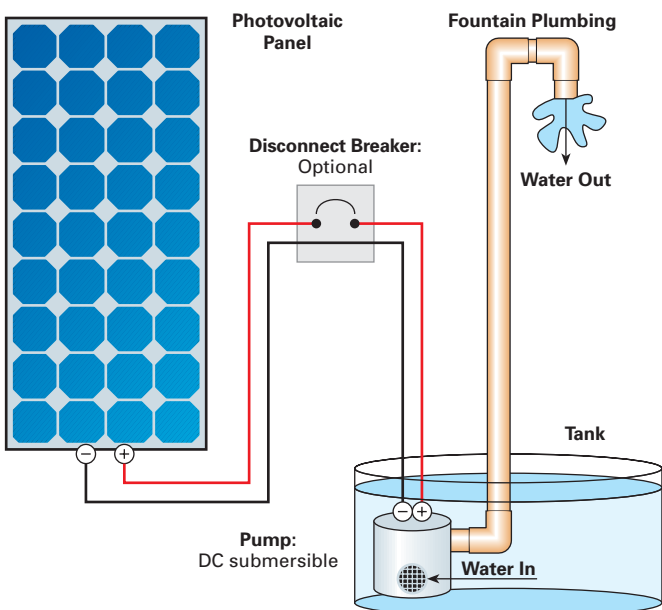

thick, clear plastic tubing that has an *inside* diameter of $\frac{5}{8}$ inch, with a hose barb and adaptor to the copper pipe. The other end of the plastic tubing will fit over the outlet on the pump. Most of the pumps listed in the table below are designed for a $\frac{3}{4}$ -inch plastic hose. However, the $\frac{5}{8}$ -inch plastic tubing will squeeze on if you dip the end in very hot water for a while to soften it up.

If you are snaking flexible plastic hose up the fountain or using a rigid plastic pipe, the connection will depend on the diameter of the hose or pipe you use. We typically use $\frac{5}{8}$ -inch clear tubing attached to the pump. To make connections, use hose barbs—these connectors will slip on easily but resist sliding off.

Step eight—wire the PV and pump. Mount an outdoor junction box near the pump. The wires from the water pump

and the wires from the solar-electric panel meet in this box. The purpose of using the box is two-fold. It provides a weather-resistant enclosure for the electrical connection and makes it easy to replace the pump when it wears out.

The wire from the solar-electric panel to the electrical box can either be rated for the outdoors (sunlight and moisture resistant, and designed for direct burial) or it can be run in conduit. It is important to provide strain relief on the wire by using fittings that make a firm mechanical connection at the solar-electric module frame to prevent damage to the panel, and the possibility of the wires being pulled loose from their connections.

Because PV modules are limited current devices, the *National Electrical Code (NEC)* does not require a DC fuse or breaker in PV-direct pumping systems as long as all the

Putting Fountain Pumps to the Test

Test Conditions: Pumps were tested twice on clear sunny days: from 1 to 3 PM (Daylight Savings Time) on October 29, 2004, and from noon to 2 PM (Standard Time) on November 2, 2004, using one or two, 30-watt, 18-volt solar-electric modules.

The test fountain was built out of lengths of $\frac{1}{2}$ -inch copper pipe. The various heights were created by screwing on additional lengths of $\frac{1}{2}$ -inch copper pipe. The pump was connected to the copper pipe using 44-inch (112 cm) lengths of $\frac{5}{8}$ -inch ID clear plastic tubing.

Amperage was measured with a digital multimeter. The pumps were tested using first one 30-watt module and then two 30-watt modules wired in parallel. You can see how the performance varies depending on the size of solar module you choose. Test data between the two days was fairly consistent. When there were differences, the gpm figure was averaged between the two tests.



A pump is attached to the copper pipe and wired to a solar-electric module.

Gallons per Minute at Head

Pump (& # of 30 W modules)	Gallons per Minute at Head				Amps	Cost (US\$)	Pump Type
	1 ft.	3 ft.	4 ft.	5 ft.			
Attwood V500 (1 module)	5.5	4.3	3.0	2.8	1.50	\$16	Marine bilge
Attwood V500 (2 modules)	8.0	6.5	6.0	5.5	2.50	16	Marine bilge
Rule 360 (1 module)	4.0	2.8	2.2	1.8	1.50	16	Marine bilge
Rule 360 (2 modules)	6.0	5.2	4.5	4.0	2.50	16	Marine bilge
West Marine Gyro 450 (1 module)	4.6	3.0	2.2	1.5	1.40	19	Marine bilge
West Marine Gyro 450 (2 modules)	6.5	5.3	4.8	3.3	2.40	19	Marine bilge
Aquasolar 700 (1 or 2 modules)	2.4	1.2	0.5	—	0.23	180	Solar fountain



Satisfied teachers and leaders of the second Solar Schoolhouse Summer Institute gather around the fountain made of gold pans at Sly Park School. The Siemens M55 solar-electric module runs the fountain even in reduced light situations.

Solar fountain projects create infinite opportunities to combine art, solar energy, science, and education. They are also easy to build. Depending on your design, you can build one in an afternoon or a week. It is an opportunity for a collective artistic experience in which you can just put out a pile of materials, some tubing, a pond liner, a pump, wire, and a PV module, and start creating.

Access

Hal Aronson, Solar Schoolhouse Program (The Rachus Institute) & The Solar Energy Education Program (Berkeley EcoHouse), PO Box 5679, Berkeley, CA 94705 • 510-665-7747 • hal@rachus.org • www.rachus.org

Tor Allen, The Rachus Institute, Solar Schoolhouse Program, 1535 Center Ave., Martinez, CA 94553 • 925-370-7262 • tor@rachus.org • www.rachus.org • www.solarschoolhouse.org

wiring is sized to meet NEC ampacity requirements. It's still a good idea to include a DC breaker in the system, which can be used to disconnect the PV module from the pump if service is required.

Step nine—use the fountain! People are attracted to fountains. Fountains can be meditative, playful, beautiful, forceful, graceful, expressive, political, or historical. They can be built by skilled artisans or schoolchildren and teachers. They can be built from almost any material that does not dissolve in water—such as driftwood, scrap metal, ceramics, stone, sculptural pieces, or broken dishes.

Moving water brings a place to life. The fact that the fountain is powered by sunlight, a magical and pollution-free energy source, makes it that much more exciting. Fountains create soothing places of calm that are particularly helpful in hectic locations like schools. On a hot day, they can also keep you cool.

Sly Park Environmental Education School, 5600 Sly Park Rd., Pollock Pines, CA 95726 • 916-228-2485 or 530-644-2071 • mbastian@scoe.net • www.scoe.net/slypark

West Marine, PO Box 50070, Watsonville, CA 95077 • 800-262-8464 or 831-728-2700 • Fax: 831-761-4421 • customercare@westmarine.com • www.westmarine.com • West Marine, Attwood, & Rule bilge pumps

Sly Park Fountain Costs

Item	Cost (US\$)
Siemens M55 module (used)	\$200
Pond liner material	65
Mount materials & hardware	25
Rule pump	16
Copper plumbing, 1/2 in.	12
Wire	10
Total	\$328

ALTERNATIVE POWER EMERGENCY KIT NEW

Freeplay Ranger
Wind Up Radio
AM/FM with Built-in Solar Panel

Freeplay Sherpa
Wind Up Flashlight
with Dual Intensity Xenon bulb

both for only
\$79⁹⁵

FREE Catalog #15

C. CRANE COMPANY

FREE US Ground Shipping On Orders Over \$25

800-522-8863 • ccrane.com

THERMOMAX.COM

EVACUATED HEAT-PIPE SOLAR COLLECTOR SOURCE



The Perfect Solar Heating System

23 Years Track Record • Attractive Design • Flexible • Low Wind Load
Frost & Corrosion Free • Durable • High Heat Transfer • Reliable

Please visit www.thermomax.com for our products and services

5560 Sterrett Place, Columbia, Maryland 21044

E-mail: info@thermomax.com

Phone: (800) 75SOLAR7, (800) 775-5277

Hutton Solar

"Where To Find What You Design."



Hutton Solar understands your time is valuable. That's why we provide real-time access to the best solar and solar-related products from the top manufacturers in the industry. Hutton Solar offers:

- The largest variety of Solar products from the top manufacturers in the industry.
- A high-tech website for research & online ordering
- Technical application and design support
- Three regional warehouses for quick delivery

Looking for a Dealer/Installer in your area?

One of the most frustrating and time-consuming aspects of any project can be finding the right resources. With Hutton Solar's expansive dealer/installer network, we can connect you with the qualified experts who will get the job done right, coast-to-coast. Log on to Huttonsolar.com and use the "need a dealer in your area" feature on the home page, or call 877-648-8866 for personal assistance. Let Hutton Solar work for you!

huttonsolar.com
The true leader in solar products distribution

www.huttonsolar.com • 877-648-8866

HuP[®] Solar-One[™] Batteries

Tired of Receiving **Broken Plastic Batteries?**

The **HuP Solar-One** battery is virtually indestructible because of the epoxy coated steel case! In fact Northwest Energy Storage will pay up to \$100.00 for any **HuP Solar-One** damaged in shipment.

Don't forget about the new reduced maintenance warranty, and paid service calls for all authorized **HuP Solar-One** dealers!

For information on the **HuP Solar-One** battery and our complete line of RE products contact:

Northwest Energy Storage

800.718.8816 or 941.697.1344 Fax 941.697.0767
www.nwes.com www.hupsolarone.com batteries@nwes.com

HuP Solar-One, The Better Built Battery[®]

Dealer Inquiries Invited!
Many Models In Stock!



4 Things You Should Expect When Choosing Renewable Energy Equipment

The decision to live with renewable energy is a long term commitment. To make the right decision consider the following:

- **Inventory**: Make sure your supplier can provide what you want, not what they have.
- **Experience**: Does your supplier use what they sell?
- **Service**: 78% of Renewable Energy suppliers are part time. Make sure yours is full time.
- **Knowledge**: Make sure your supplier can answer all of your technical questions without giving you the run around and leaving you even more confused.



FREE
Solar Design Guide

Packed full of industry secrets, useful charts and product selection guides.

www.nationalsolarsupply.com/free

Sun Frost

Energy Efficient
Refrigerators & Freezers
Customized To Fit Your Needs



- ▶ Available in DC or AC
- ▶ Select From Over 10 Models
- ▶ Choose from 1000's of Colors, Finishes & Woods

Providing an Effective Alternative for Energy Conscious Consumers.

Now Making Stylish Home Composting Systems Too!

Please Contact Us For More Info

P.O. Box 1101, Arcata, CA 95518
tel: (707)822-9095 ■ fax: (707)822-6213
info@sunfrost.com ■ www.sunfrost.com

When Reliability and Performance Matter...

THE WORLD'S LEADING SOLAR CONTROLLERS

MORNINGSTAR Corporation
www.morningstarcorp.com

SunPumpsTM Inc.

SOLAR PUMPING PRODUCTS



Brushless DC Submersible Pumps up to 2 HP, heads up to 700 feet and flow rates up to 50 GPM.



Diaphragm Submersibles with heads up to 230 feet and flow rates up to 5 GPM.



Centrifugal Booster Pumps from 12 volt Home Pressure Systems to 180 volt High Pressure Booster Pump Systems.

Quality First!



Pool Pump Kits from ½ to 1½ HP.



www.sunpumps.com

1-800-370-8115
Phone: (928) 348-9652
Fax: (928) 348-9653

Solar-Powered e-mail

From the Wilderness

Bill Layman

©2005 Bill Layman



The author's wife Lynda takes a break on the gear-covered canoe.

My mining exploration company and my wife Lynda's work as an educator put us in close contact with Saskatchewan's Athapaskan Dene—aboriginal people who live along the edge of the tree line in Canada's far north. A fascination with the stories these people told us about their ancestral lands and their parents' and grandparents' nomadic lives convinced us that we wanted to venture into their region.

We have now done ten trips and some 8,000 miles (13,000 km) of paddling in Canada's subarctic, and each year when we come home, everyone we meet wants to know all about our summer adventures. About five years ago, a friend asked if I had considered doing an Internet journal about our trips. His question got me thinking about whether the idea was doable.

I asked a friend who owns a radiotelephone dealership. "The good news is that you can do it," he said as he went into the back of his store. I watched as he struggled back to the counter with a huge suitcase. "Here's the bad news," he said as he opened the case to show me about 30 pounds (14 kg) of radio gear. "And to power it, you need a car battery and a way to keep it charged." Short of hiring four Sherpas and bringing another canoe and a power plant, my friend's journal idea was stopped dead, right there.

Globalstar to the Rescue

A year later, I came across an ad for a new satellite phone made by Globalstar. My eyes lit up when I saw how lightweight, portable, and energy efficient this phone was. My friend's idea of e-mailing a Web journal from the wilderness started to dance about in my brain again.

It was a real "vision quest" getting the e-mail problem sorted out. I could glaze your eyes over with all the details, but suffice it to say that I got a Palm III XE (a personal digital assistant or PDA) talking to the phone after what seemed to be a million failed experiments. A PDA is only a few steps above a cell phone for text, so you need a keyboard to be able to type. With a portable keyboard from LandWare, I had the e-mail thing figured out, and started to "dump data" for the 'Net (go to www.out-there.com/BL.htm to have a look).

The Palm III XE was great since it used AAA batteries, and I could just carry a supply with me. The phone's battery was good for 3.5 hours of TX time (tech-weenie talk for transmit), so taking a couple of batteries saw me through a trip. In short, I didn't need to recharge the Palm and the Globalstar.

Batteries to Charge

"So why don't you figure out how to send pictures back for the Web next year?" my friend said after a slide show one winter. Not being one to shy away from a challenge, I spent the next few months trying to figure out how to get a photo from the tundra up to a satellite and back down to Montreal. I needed a new PDA to do this because the Palm just couldn't handle it. I finally got a Hewlett Packard Jornada 565 (with a plug-in camera similar to what you see on some cell phones now) talking to my phone via a CompactFlash card to a serial cable from Socketcom Communications.



High tech in the tundra: The author uses a PDA and portable keyboard to send e-mail from his campsite.

And what did I do once this hurdle was cleared? I sent a picture of my car in the driveway back to my car in the driveway. "Wow isn't that cool!" I can hear you gasp! And it only took a few months of screwing around, about a million phone calls, and a few prayers to the electronics gods. But you know, even now when I take a picture of a musk ox or a caribou herd and send it back from the tundra, it still blows me away.

The upside of this experiment was that I could send pictures. The downside was how to charge the Jornada's lithium-ion batteries. I could carry multiple batteries, but they are ridiculously expensive. And since I would be using several minutes a day of phone time to send the pictures, I'd need three or four phone batteries. Given the cost of all the batteries, a solar charging system suddenly became cost-efficient. So back to the drawing board I went.

Portable Uplink System Costs

Item	Cost (US\$)
Globalstar GSP 1600 phone (battery = 1,400 mAH, 7.5 V)	\$749.00
Hewlett Packard Jornada 565 PDA (battery = 1,200 mAH, 3.2 V)	200.00
Iowa Thin Film R15-600 panel (output = 0.6 A, 15.4 V)	225.00
CompactFlash card, serial I/O with cable (tiny energy use)	169.00
Camera for Jornada (draws power from PDA)	75.00
GoType! portable keyboard for Palm (tiny energy use)	30.00
Palm III XE PDA (2 rechargeable AAA batteries)	25.00
Total	\$1,473.00

Flexible PV

I had almost given up hope of finding a compact, efficient way to charge the Globalstar phone and the PDA, when I saw an article in *Wired* magazine about roll-up solar-electric panels. A phone call to Steven Martens at Iowa Thin Film Technologies, and I had a new R15-600 roll-up panel in the mail. Steven thought that their panel would do the trick for me, but I think they got a little worried when I said I'm hard on my canoe gear.

Did it work? Man, did it! I like gear, but only if it is rugged, well thought-out, and foolproof. This panel is the full-meal-deal, and I showed it no mercy. Delivering 0.6 amps at 15.4 volts, it kept my phone and my PDA charged and happy. So happy that I was soon reading digital books and playing Scrabble on the PDA.

For some reason not fathomable to me, most new PDAs, and many other peripherals, have an internal battery that you can't get at to change—you are forced to charge it in the device. It seems that the manufacturers assume that we all live within three hours of the grid. Well it just ain't so.

With one of these panels, you are still in the game. Just get the automobile DC cigarette plug adapter for each of your various peripherals and start using the sun. And when you have wandered away from the grid with your digital camera, boom box, electronic games, notebook computer, or CD player, you will still be wired. If you need more electricity, you can just add more panels.

So whether you are on a bicycle or car-camping trip, a weekend picnic, or on a sailboat without a motor for charging, these panels are worth looking at. As to the height of "cool ideas," Iowa Thin Film is actually building tents with the panels built right into the roof. Now where can I get one of those and how can I convince Lynda that we need it?

Tundra Travelogue

When I first started to send e-mails to our Web site from the tundra, I agreed with the editor that I would send in about 500 words a week. "I mean, what's there to say?" I reasoned, "Got up, paddled, had supper, slept...repeat for 30 days."

An Iowa Thin Film panel hung on the side of a tent charges the PDA.



Besides, I thought I wouldn't be real anxious to type out an e-mail at the end of a hard day.

Was I ever wrong! The first day saw 500 words and the next even more. There was just so much to say and describe. When we're out on the water, our Web host's site tops 3 million hits per month. More than a few people must like what I'm writing!

Every day, I absorb all I see and all that happens—the land, the water, the animals, the weather—and I build phrases in my head. And when we stop, I can't wait to write it all down. The words tumble out, tripping over each other as I rush to type them. Sometimes the words make me cry for the beauty of all I have seen. This crafting of words has changed the way I see the tundra. And when I re-read it all at home, I relive the passion of each day. I couldn't do this by memory alone or from my hurried scrawls in a notebook.

By posting my daily journal, I can share all I have seen with those who can't be with me. I'm able to give away the passion that builds in me each day. And someday when I'm too old to be out on the land, I can read my own words and smile for all I have seen. And maybe, just maybe, my words will help see this land remain unchanged for all time.

Access

Bill Layman, PO Box 327, La Ronge, SK, Canada S0J 1L0 • 306-425-2858 • layman@cableronge.sk.ca • www.out-there.com/BL.htm

Globalstar, Fintan Robb, 461 So. Milpitas Blvd. Bldg. 5 Ste. 1 & 2, Milpitas, CA 95035 • 905-712-6662 • frobb@globalstar.ca • www.globalstar.com • Satellite phone

Socketcom Communications Inc., Tatia Meghadi, 37400 Central Ct., Newark, CA 94560 • 510-744-2751 • Fax: 510-744-2727 • tatia@socketcom.com • www.socketcom.com • Serial cable

LandWare Inc., 690 Kinderkamack Rd., Oradell, NJ 07649 • 201-261-7944 • Fax: 201-261-7949 • info@landware.com • www.landware.com • Portable keyboard

Iowa Thin Film Technologies, 2337 230th St., Boone, IA 50036 • 515-292-7606 • Fax: 515-292-1922 • smartens@iowathinfilm.com • www.iowathinfilm.com • Roll-up PV

"Our Remote Home Radio Antennas," by Bill Layman in HP90

"Solar in the Frozen North," by Bill Layman in HP68



Planetary Systems
power your environment

Innovative Power Package features:

- Save installation time & money with plug-n-play design
- Patented, modular & pre-tested prior to shipment
- High quality system components
- Meets NEC-690 standards
- Grid-tie or stand alone power capability
- 15 models available - sized to meet your needs

xantrex Certified Dealer

Planetary Systems, Inc.
P.O. Box 340 / 262 Badger Rd., Ennis, MT 59729
Phone (406) 682-5646 FAX (406) 682-5644
www.planetarysystems.com

ADVANCED COMMUNICATION SOLUTIONS INC.
"Keeping you connected to your world"

Satellite Phones / Radio-telephones / Home Cellular Cellular Amplifiers & In-Building Repeater Systems Antennas / Long-range Cordless Phones / RF Cables

Globalstar
Satellite Phones

CellSocket

VOYAGER

MAXRAD

EnGenius

ANTENEX

Prescott Valley, Arizona • (928) 772-7515
www.advanced-comm-solutions.com

AUTOMAGIC BATTERY WATERING



WE MAKE WATER FROM YOUR GAS

Hydrogen and oxygen battery gas catalytically recombined into pure water and returned to each battery cell. Keeps battery topped off for extended periods of time and reduces maintenance costs. Explosive hydrogen gas is virtually eliminated from the battery area. Corrosive spray and fumes are contained and washed back into each battery cell. Electrolyte kept strong longer, extending the useful power and life of the battery. HYDROCAP Vents simply replace the battery's caps. Battery maintenance is greatly reduced. Write or call for more information.



Things that Work!



305-696-2504
975 NW 95 St.
Miami, FL 33150

SunDanzzer
Cool with Solar

- Energy-Efficient
- Automatic operation
- Thick polyurethane insulation
- Lockable lid
- Interior light
- Corrosion resistant coated steel exterior
- Patented low-frost system
- Easy to clean interior
- Low maintenance

12/24 VDC Energy Efficient Refrigeration

(866) Sun-Danz
(866) 786-3269
www.sundanzzer.com

Harness the power of the sun



GREEN GRIDTIE™ solar power system

Complete power solutions for your home



Call to find an Authorized SPS Energy Dealer in your area

Olympia, WA 1-800-685-7940 Santa Cruz, CA 1-800-635-7497 Temecula, CA 1-866-293-8876 Riverton, UT 1-800-671-0169

www.spsenergy.com

Solid Investment

Solar systems will produce electricity far into the future.

Energy Independence

You will have a smaller bill from your utility.

Affordable Energy

Some utilities offer tax breaks, incentives and rebates to further reduce the cost.

Stewardship to a Cleaner Environment

Solar electricity reduces green house gases. The future is brighter with solar.



GREEN GRIDTIE™

solar power system

Quiet Reliable Solar Electricity Wherever You Need It

Powerwagon

Everything in one self-contained, mobile, solar power system—all components designed and tested to work together!

This Mobile System Is Ideal For:

*Cabins • Construction • Backup Power
Off Grid Living • Solar Feasibility Testing
Quiet Emergency Power*

Independent Energy Systems



www.independentenergy.biz • 989-872-4848
1935 Dodge Rd. • Deford, MI 48729

SUNFRAME®

PV MODULE FRAMING AND MOUNTING SYSTEM FOR PITCHED ROOFS

Add aesthetics to the benefits of PV power

Low, clean lines. Your choice of clear or dark bronze anodized finish. Like a skylight, SunFrame becomes a natural feature of any home.

To be sure, it also meets strict structural standards, including Uniform and California building codes, and delivers the installation ease you've come to expect from UniRac.



www.unirac.com

UNIRAC®

THE STANDARD IN PV MOUNTING STRUCTURES™

U.S. and other patents pending.

UniRac, Inc. 505.242.6411 505.242.6412 Fax
3201 University Boulevard SE, Suite 110 • Albuquerque NM 87106-5635 USA

Harris Hydroelectric

Hydro-Power for Home Use

Introducing a new adjustable
Permanent Magnetic Brushless Alternator

- 25 - 30% more efficient than Hi Output Alternator
- Marine Grade Construction throughout
- Re-connectable Stator
- Retrofittable on existing turbine



632 Swanton Road
Davenport, CA 95017
831-425-7652



www.harrishydro.com

JACOBS®

WIND ENERGY SYSTEMS

Big Swept Area (up to 660 sq.ft.)
 Equals Big Power (up to 20 kW)

The Jacobs® wind energy systems have over 70 years of history providing clean, quality, reliable and efficient power in the USA and around the world.

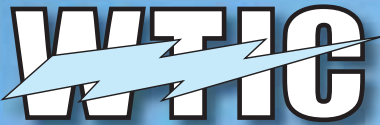

WIND TURBINE INDUSTRIES CORPORATION

The exclusive manufacturer of Jacobs wind energy systems since 1986.

16801 Industrial Circle S.E., Prior Lake, MN 55372
 (952) 447-6064 Fax (952) 447-6050

wtic@windturbine.net • www.windturbine.net
 President: Archie J. Pavsek • Manager: Steven T. Turek

Protecting Our Environment

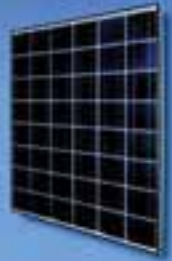

Serving Customers Around the World Since 1979

Solar electric systems, solar panels,
 wind generators and deep-cycle
 batteries for boats, houseboats & RVs.

www.solar-electric.com

(800) 383-0195 • (928) 526-8017

2725 East Lakin Drive, Flagstaff, AZ 86004
 fax (928) 527-0729 • windsun@wind-sun.com

VENA QUAD DISPLAY PANEL METERS

AC/DC MONITOR

VENA

BAT 1

13.2 VDC 3.40 A

120 VAC 60 Hz

ALARMS ON



Measures:

- DC Voltage
- DC Current
- AC Voltage
- AC Frequency
- AC Current
- Temperature
- Time

Features:

- User Selectable Alarms
- Backlighting
- Large Display



*Shown actual size

Vena Engineering Corporation

831.724.5738

<http://www.vena.com>

How Efficient Is Your House?

Comprehensive Home Energy Analysis

Allison A. Bailes III

©2005 Allison A. Bailes III

Every dollar you spend on efficient appliances will save you roughly three to five dollars in renewable energy equipment costs. So it's no surprise that *Home Power* regularly advises you to install compact fluorescent lightbulbs and other efficient appliances before you make a substantial investment in a renewable energy (RE) system. The first step in your renewable energy journey should be to make your house as efficient as possible, and this process always begins with a thorough analysis of your home's energy use.

A recent article in *HP102* explains the process of figuring out how much electricity you use so you can size your RE system appropriately. If all you care about are lights and plug loads (such as refrigerator, computer, microwave, etc.), the method described in that article works well. But how do you determine how much energy your home uses for heating and cooling?

In the past decade, a new group of professionals has emerged that can handle this problem—home energy raters. By treating the house as a system of many interacting parts, home energy raters estimate the energy usage of a house. By getting a detailed energy analysis, homeowners can make informed decisions about improvements that will decrease the energy usage of their home.

Home Energy Ratings

A home energy rating has three important parts:

- A plan review or inspection
- Diagnostic testing
- Computer analysis

The first step entails gathering information about the insulation, windows, water heater, and heating, ventilation, and air-conditioning (HVAC) efficiencies, dimensions, and all of the other data important to home energy use. Blower door and Duct Blaster tests, the second step, determine the air leakage of the whole house and of the heating/cooling duct system. The last step is crunching the numbers from the first two steps.

The heart of the Home Energy Rating System (HERS) analysis lies in calculating the heating and cooling loads for the house. The rating software finds the amount of heat that



Home energy rater Allison Bailes arrives at a home to conduct blower door and Duct Blaster tests.

you need to put into the house in the winter to overcome the heat that the house loses through the building envelope. That's the heating load. The amount of heat that you have to remove from the house in the summer is your cooling load.

Heat can move from one place to another in three ways—conduction, convection, and radiation. Conduction (direct contact) is what cooks the eggs in your frying pan. Convection (fluid mixing) is the reason that it's usually warmer upstairs. And radiation (electromagnetic energy moving through space) heats up your parked car.

The HERS software considers conduction and radiation of heat through the building envelope—the boundary between the interior, conditioned space and the surrounding unconditioned spaces. Houses have evolved to the point where they now provide carefully controlled indoor environments in addition to shelter from wind, sun, and rain. To maintain these conditions, the building envelope must have two main components—a continuous air barrier and complete insulation coverage.

Heat conduction through a material, such as a wall, depends on the temperature difference across the wall,

the wall thickness, and the composition of the wall. The thickness and composition of the wall determine the R-value, the resistance of the wall to heat flow.

The HERS software uses climate data for the house's location to determine the temperature differences that exist across the building envelope for the average heating and cooling seasons. Combining these temperature differences with the R-values for all the building envelope surfaces (floors, walls, and ceilings), the software then calculates the heat lost or gained through conduction.

Heat loss or gain via radiation happens through windows. By telling the program the amount of window area, the solar heat gain coefficients, and the window orientations (north, northeast, east, southeast, etc.), the effects of radiation on heating and cooling loads can be determined. To account for passive solar features, the software can process overhang and thermal mass information, as well as the details of attached sunspaces (solar rooms, greenhouses, or other additions to a building).

Of course, many other factors should also be considered in calculating the loads. The rater needs to know the foundation type, the wall and roof colors (dark, medium, light, or reflective), and the amounts of air infiltration/exfiltration and duct leakage.

A blower door test can tell you how leaky—or tight—your home is.



Becoming a Home Energy Rater

The home energy rating industry is growing. Energy codes are becoming more stringent, and they're starting to be enforced. In addition to Energy Star homes, other programs depend on home energy ratings—U.S. DOE's Building America Program, the Environments for Living program, and regional green building programs.

If you're interested in the HERS training, several organizations around the country offer it. You can find them listed on the Residential Energy Services Network (RESNET) Web site under "Rater Training Opportunities." Classes run for a week and cost about US\$800.

In the training, you'll learn the fundamentals of building science, that is, how to look at the whole house as one system of many interacting parts. You'll also learn how to conduct blower door and Duct Blaster tests and use the rating software. At the end of the week, you get tested on all the things you learn.

Once you pass the tests, you've completed the first stage of becoming a certified HERS rater. The next step is to find a HERS provider, an organization to which you send all of your ratings for certification. After you sign up, you have to perform a certain number of provisional ratings (usually 3 or 4) and have them approved by your provider. When they're satisfied that you know what you're doing and you've met all their requirements, you become a certified HERS rater.

After the program has determined the heating and cooling loads, it calculates the energy consumption necessary to satisfy those loads. How is consumption different from load, you ask? Each KWH of needed heating and cooling does not necessarily result in a KWH used; your HVAC equipment will usually use less than one KWH or more than one KWH.

If you have a 92 percent efficient gas furnace, you have to burn the equivalent of 100 KWH to get 92 for heating, so your consumption is higher than your load in this case. If instead, you have a heat pump, you're just *moving* heat instead of generating it. This type of unit can move about 3 KWH worth of heat using only 1 KWH. Here, then, your consumption is going to be less than your load.

Resistance heating, the kind you find in toasters, is 100 percent efficient, so its consumption-to-load ratio is 1. (100 percent efficiency may sound good, but it's not. Look back at what I said about heat pumps, and you'll see why.) If

you're making your own electricity with renewables, or even just trying to make your house more efficient, you'll want to use the most efficient heating system available.

Two additional energy components—water heating, and lights and appliances—combined with heating and cooling, complete the energy consumption picture. The water heater type and efficiency goes into the program to find its load.

When a rater enters the necessary data into the HERS software, the computer does all of the load and consumption calculations described above. You can also get reports that show information about the air leakage of the house, the pollution associated with your energy use, HVAC equipment sizing, and much more. If you like technical data, you'll love these reports!

Blower Door & Duct Blaster Testing

One of the most important aspects of home energy ratings is that they are performance-based. Two diagnostic tests can determine the house's rate of infiltration/exfiltration (blower door test) and the air leakage of the heating/cooling duct system (Duct Blaster test).

The blower door test measures how difficult it is to pull air out of the house when it's all closed up. The rater closes the windows, doors, fireplace dampers, and other openings that are normally closed when the HVAC system is running. The blower door itself is aluminum-framed canvas with a large fan in it. When placed in a central outside doorway, it can either pressurize or depressurize the house.



Sealing the registers in preparation for the duct pressure test.

Energy Star Homes

The U.S. EPA added homes to the Energy Star program in 1996. From 1996 through 2003, about 230,000 homes obtained the Energy Star label. Nearly half of those (109,000) were certified in 2003 alone. This year may see another doubling, as the number of HERS raters and Energy Star homebuilders continues to increase.

How much energy is saved by the Energy Star program, though, depends on what you use as your basis of comparison. If you compare two similar new houses, one an Energy Star house and one that just meets the energy code, there's obviously some savings. If, however, you compare the amount of energy used by a family of four in a new Energy Star house to that used by a family of four 30 or 40 years ago, you may not see any savings. Houses are a lot bigger now, so it's possible to have an "energy efficient" house and yet not conserve energy. Small houses save energy!



To test for the rate of infiltration/exfiltration in the house, the rater generally directs the fan to blow air out of the house. As the fan pulls air out of the house, the inside air pressure drops below the outside air pressure, depressurizing the house. To quantify the process, the rater adjusts the fan until the pressure difference between inside and outside is 50 Pascals (0.00725 psi). A differential pressure gauge, connected separately to both outdoor and indoor air with small rubber hoses, determines the pressure difference, and with a conversion table, the rater can determine airflow.

The rater then uses the fan's airflow, the climate, the size of the house, and the exposure to wind to calculate the normal air changes per hour (ACH) rating for the house. This refers to the volume of air (in terms of the total volume of the house) that gets exchanged with outside air in one hour. For example, if a house has a volume of 20,000 cubic feet and an ACH of 0.5, then 10,000 cubic feet of air get exchanged each hour. A really leaky house will have an ACH of 1 or higher, and a really tight house will be less than 0.1. The standard is 0.35 ACH; anything above that is considered to have failed the blower door test.

The Duct Blaster test works pretty much the same way. You seal up the forced-air, heating-cooling duct system, connect a fan to it, and blow air in until the pressure inside is 25 Pascals (0.003625 psi) higher than outside. The amount of airflow needed to get to that pressure is a measure of how

leaky the ducts are. The criterion for this test is based on the ratio of airflow in cubic feet per minute to the floor area of the house in square feet. If that number is 0.05 or below, it passes. Unfortunately, typical new houses have ratios three to four times higher than that.

The HERS Score

The home energy rating reports provide annual energy costs (broken down into heating, cooling, water heating, and lights and appliances), heating and cooling loads, and heating and cooling consumption. Each house gets a score between 0 and 100. A score of 80 means that the house just meets the 1993 Model Energy Code. Each point above or below 80 corresponds to a 5 percent increase or decrease, respectively, in the relative energy efficiency of the house. For example, to be labeled Energy Star, a house has to have a score of 86, making it 30 percent more efficient than the same house built merely to code.

To calculate the score, the HERS software takes the information for the rated house and constructs a reference house in the background. This reference house has the same shape, size, foundation type, and amount of building envelope area as the rated house. The HERS technical guidelines specify the other features relevant to energy use. The intent is to have the reference house meet the energy code and provide a valid basis for comparison. The score, then, comes from comparing the calculated energy consumption of the rated house to that of the reference house.

Reading the digital gauge to find the pressure difference between inside and outside, and the airflow through the fan.



Connecting the Duct Blaster to a return duct in preparation for pressurizing the duct system.

The Big Picture

Home energy ratings can be a useful tool for any homeowner. So far, they've been used mainly to analyze and improve the performance of conventional, grid-powered homes, but the RE community should be taking advantage of them too. The HERS reports break down the heating and cooling consumption into the various components, such as above-grade walls, windows, infiltration, and ceilings. This allows you to put your money into those improvements that will save the most energy.

When you use a home energy rating to make your house more energy efficient, you can realize other benefits too. Tight ducts and a well-sealed building envelope can improve the indoor air quality (but only if it's properly ventilated by adding fresh air directly to the HVAC system or with an air-to-air heat exchanger). For example, a leaky return duct in a damp crawl space can send moist, moldy air into the house. Another benefit is that a well-sealed and insulated building envelope makes for a quieter house.

Anyone who is building a new home, whether RE-powered or not, should consider adding the cost of a rating (US\$300–600) to their budget. That cost may well come back in energy savings, or by being able to put in a smaller HVAC system than the contractor wants to install. If you're using RE, of course, knowing what your loads are is critical. Home energy ratings provide a *complete* picture of those loads.



Checking the attic insulation levels.

Access

Allison A. Bailes III, ab3 energy, LLC, 615 Bethel Church Rd., Carrollton, GA 30117 • Phone/Fax: 770-258-7738 • ab3@ab3energy.com • www.ab3energy.com

Residential Energy Services Network (RESNET), PO Box 4561, Oceanside, CA 92052 • 760-806-3448 • Fax: 760-806-9449 • info@natresnet.org • www.natresnet.org

The Energy Conservatory, 2801 21st Ave. S, Suite 160, Minneapolis, MN 55407 • 612-827-1117 • Fax: 612-827-1051 • info@energyconservatory.com • www.energyconservatory.com • Blower door & Duct Blaster equipment

Energy Star, 1200 Pennsylvania Ave. NW, Washington, DC 20460 • 888-STAR-YES • www.energystar.gov/homes

Building America Program • www.eere.energy.gov/buildings/building_america

“Starting Smart: Calculating Your Energy Appetite,” by Scott Russell in HP102

Word Power, by Ian Woofenden. “Efficiency—Ratio of Energy In to Energy Out” in HP101, and “Conservation—Saving Energy” in HP102



SunEARTH inc.
Quality Solar Energy Products

**THINK THERMAL-
THINK SUNEARTH**



The Empire Series Liquid Flat Plate Collector

www.sunearthinc.com

SunEarth, Inc.
8425 Almeria Avenue, Fontana, CA 92335
(909) 434-3100, FAX (909) 434-3101
Distributor inquiries welcome.



As seen in HP 90, pg 50
and HP 103 pg 72
Dealer Inquiries
Welcome

**Direct Grid-Tie
Now Available**

Reliable • Quiet • Rugged • Elegant

Solar Wind Works
~ Proven USA Distributor ~



Chris Worcester, NABCEP Certified PV Installer
CA Contractor's License: #796322



Renewable Energy Power Systems

- Sales—PV, Wind, & Microhydro
- Design—Off-Grid or On-Grid
- Installation & Service



Toll Free! 877-682-4503
PO Box 2511, Truckee, CA 96160
info@solarwindworks.com • www.solarwindworks.com



POWER-RAIL™ TOP-CLAMP MOUNTING SYSTEM



POWER-FAB
PV HARDWARE



4000-B Vassar Drive NE • Albuquerque, NM 87107 • **800-260-3792** • Fax 505-889-3548 • Email jrandall@directpower.com

ADVANTAGE SOLAR

The New Standard In Renewable Energy Product Distribution.

Whether you're an established dealer, installer, or someone who is interested in entering the solar field, Advantage Solar can provide you with the tools to make your business a success ! Our many years of experience coupled with the latest in business to business technology allows us to offer you service that's unmatched in the industry.



What's The Advantage ?

- One of the largest renewable energy product inventories in the nation !
- Comprehensive stock of balance of system components !
- Aggressive dealer pricing structure !
- Experienced technical and engineering staff !
- Drop shipments from our warehouse to your customer with your name on the label !
- Professional design assistance !
- Assistance in website creation and hosting !
- Complete system packages !
- Personal, friendly service !



Be sure to contact us regarding the new name brand solar module that we will be bringing into our inventory. Arriving soon !

Advantage Solar Inc. Toll Free 1-877-807-6527 www.advantagesolar.com

Wondering where to start?



Our **Quick Start** special! Get our last six issues and a one-year subscription for just **\$45** plus S&H. Save \$36!



Add Solar1, our Renewable Energy Basics CD-ROM, to the deal for another **\$19**, regularly \$29!

Back-issue substitutions welcome. Order online at www.homepower.com or call 800-707-6585 or 541-512-0201.

Dang.

You'd look sooooo good
in one of these T-shirts.

No, seriously.



1/3 Off Special!
Only \$10 While They Last!

Two-sided, Blue or White, Sizes: S to XXL
Shipping: \$5 US, \$8 CAN, \$10 Other Int'l

Order online at www.homepower.com or call 800-707-6585 or 541-512-0201

Renewable Energy Basics on CD-ROM

A collection of the best basics articles from 15 years of *Home Power* magazine.



\$29
(plus shipping)

- Visit our online store to view a complete table of contents for *Solar1*.
- All contents are in PDF, featuring original magazine layouts as published.
- Get this or any *Home Power* CD-ROM for \$19 with your one-year subscription.

Order by phone at 800-707-6585 or 541-512-0201
or online at www.homepower.com

Missing Something?

Most *Home Power* back issues are still available!
Prices vary. Complete set (70): \$150 + S&H.
See our index of articles at www.homepower.com



Issue 105 Feb/Mar 2005

Tools of the Trade • Solar Design
Blunders • Wind Tower Basics •
Microhydro Intro - Part 3 • Tankless Hot
Water • Ford Hybrid SUV • And more!



Issue 104 Dec/Jan 2005

Solar in Brooklyn • Solar Electric Basics
• Green Building Top 10 • Microhydro
Intro - Part 2 • Choosing a Fridge • Solar
Hot Tubbing • Pedal Power • And more!



Issue 103 Oct/Nov 2004

Pete Seeger Picks Solar • Microhydro
Intro - Part 1 • Adobe Building Primer
• RE Financing • Masonry Heaters •
Washing Machine Spin-Off • And more!



Issue 102 Aug/Sept 2004

Solar- and Wind-Powered Green
Businesses • How-to Load Analysis •
Wind Basics • Small PV System • MPPT
Basics • Toyota Prius • And more!



Issue 101 Jun/Jul 2004

Straw Bale Construction • Grid-Tie and
Off-Grid Solar • Hybrid Vehicles • Solar
Thermal Heating • Hydrogen Debate •
Efficiency Ideas • And more!



Issue 100 Apr/May 2004

Wind & Solar Grid-tie • RE Myths
Debunked • Solar Investment • Solar
Hot Water History • Sun Science • Straw
Bale Building • And more!

PDF back issues available for download at www.homepower.com
Also available on CD-ROM.

Order online or call 800-707-6585 or 541-512-0201

New Life for Your Old Water Heater

Water Heater & Solar Tank Anode Rods

Chuck Marken

©2005 Chuck Marken

Most people aren't too concerned with the life of their water heater or storage tank—until it starts leaking. A pound of prevention with water heater tanks can save you one or two hundred pounds of grief. If you want to know more about how to make them last longer, follow along.

Tank Construction

Gas and electric water heater tanks and glass-lined storage tanks are very similar. The water heaters have thermostats

and heating elements or burners built in, but the tank is the same as a solar storage tank. They are all glass-lined, welded steel cylinders. There are five large manufacturers of glass-lined tanks in the United States, and about twenty small manufacturers.

The glass lining in a tank serves to prolong the life of the steel tank. Unlined steel tanks can have very limited life spans, sometimes less than two years. With the glass lining, manufacturers can feel comfortable offering five- to ten-year warranties. Tanks normally last at least twice the period of the warranty.

One thing the glass lining does is keep the water from being rust colored. It also helps protect the steel tank, but the lining always seems to have a few flaws. These may be caused during shipment, or they might be manufacturing defects. Leaks in tanks always seem to occur at the welds. This is probably the weakest point, where the lining is most likely to chip or otherwise be harmed. The lining helps, but the real protection of the steel tank comes from the anode rod.

Anodes & Corrosion

Corrosion in tanks results from a flow of electrical charges. The anode is the electrode where oxidation (corrosion) occurs. The cathode is a metallic electrode receptive to the flow of charges from the anode.

Metals have a hierarchy of sorts when it comes to corrosion. Precious metals like platinum, gold, and silver (in that order) will all corrode more slowly than metals at the other end of the scale. Zinc, aluminum, and magnesium will corrode much more

Don Keefe of AAA Solar lifts out the remains of a used-up anode rod.



quickly than the precious metals. Stainless steel will corrode a little faster than the precious metals, but not as fast as copper or steel.

Common metals that a plumber should be familiar with are copper, steel, aluminum, and magnesium. These four metals are listed in the order of resistance to corrosion in relation to the other metals in the group. The higher metal will act as a cathode in relation to metals lower on the list; the lower metal will be the sacrificial anode.

Copper, when present in a water system with any of the other common metals, will act as a cathode. The other three metals will act as an anode. Steel and copper together will always create a situation where the steel is constantly undergoing deterioration. Aluminum and magnesium are better anodes to copper than the steel tank. Take a magnesium rod, immerse it in the tank, and it will act as a sacrificial anode before the steel tank does. It's very simple and very effective.

There's only one problem with using an anode rod—it will deteriorate and disappear over time. How long the rod lasts depends on the water quality. Salty water and over-softened water accelerate the deterioration of the anode rod. After the anode is gone, the next metal present in the system will become the anode. In this case, it will be the steel of the tank. Anywhere there is a flaw in the glass lining becomes fair game for the corrosion. Once a leak starts, the tank is history.

Gas Water Heater Anatomy

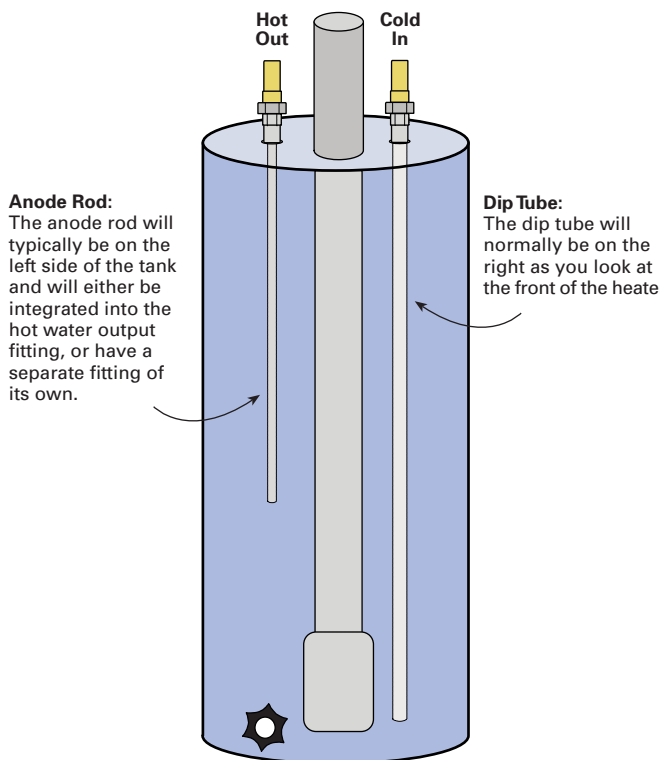

Anode Rod Replacement—Step by Step

1. If the water heater is electric and has electricity hooked up, turn off the breaker—probably a two-pole, 30-amp breaker. If it's a gas heater, turn the thermostat to the lowest setting or turn the gas valve completely off.
2. Turn off the cold water going to the tank—usually a gate valve—and drain a little water from the tank using a garden hose at the bottom of the tank.
3. Locate the anode rod. It is usually on the hot water side—the left as you look at the cover plates on the sides of tanks and water heaters. It should also be stamped in the sheet metal at the top of the tank—H for hot, C for cold. You may have to use a short ladder to see the stamping.

Some water heaters may have the anode rod attached to a square- or hex-headed plug in the top of the tank. The sheet-metal top of the tank may be stamped "Anode" next to this fitting.

4. Using care and an appropriate wrench or socket, unscrew (counterclockwise) the fitting on the top of the tank. This fitting can be tough to get loose, and may require lots of leverage. If you're lucky, the pipe nipple and anode rod will start unthreading right at the threads in the tank itself. If the nipple doesn't unthread at the tank fitting itself, you may have to use a pipe wrench on the nipple threads. Use care—they can easily be ruined.
5. Pull out the old anode rod. If the anode has half or less of the magnesium remaining (compare it to the new rod), replace it. Overhead clearance can be a problem with new anode installation, since the new rods are 3 to 4 feet (0.9–1.2 m) long. If this is a problem, use a bendable rod, but try to keep it as straight as possible to prevent it from hitting the top element in an electric heater or the flue in a gas heater.
6. Apply Teflon tape or pipe sealer to the threads on the anode rod nipple. Tighten it down sufficiently and turn the cold water valve on. Make sure to turn the breakers back on for electric water heaters or readjust the thermostat for gas heaters. Don't forget to check for leaks!

Anode Rod Replacement

New anode rods are smooth cylinders about a 1/2 inch (13 mm) to 3/4 inch (19 mm) in diameter. Used-up anode rods look like they have been dinner for some small metal-eating animal. The thin metal wire in the center of the rod is the steel core. If it's all that's left, there is no sacrificial anode.

If your tank is more than ten years old, chances are the anode is getting long (short) in the tooth. It is fairly easy to check, but you should have a new anode on hand if you take the old one out. They almost always need replacing, and if you have a new one on hand, you'll know how much the other has corroded.

If your used anode rod looks anything like the old ones in the photos, it's time to feed the tank a new one. If it is halfway between the used one in the photo and the new one, it probably still has at least a few years left before it will need replacing. If in doubt, replace it. On virtually all tanks manufactured in the last few decades, the new hot water nipple with attached anode rod should screw into the existing port with ease. Use Teflon tape or a good grade of pipe dope to seal the nipple/anode rod replacement.

Most plumbing supply houses and solar professionals carry replacement anode rods, but they might be tough to find at a home center. They come in both magnesium and aluminum, and can be found at many locations on the Web. Almost all tanks have magnesium rods. In certain areas of the country, the tanks are sold with aluminum rods because magnesium has been known to cause some noxious odors in the water.

If you can't find an anode rod replacement, I have heard of people using small pieces of magnesium dropped into the tank through one of the openings. If you try this, make

Old and new anode rods.



Installing a new rod in the tank.

sure you take the pipe nipple out of the tank. Otherwise, you might clog the dip tube or hot entrance above the anode rod.

I have never used aluminum as an anode rod, but they are available and it makes good sense that they will work fine. I have seen solar hot water systems with aluminum collector absorber plates that developed leaks quickly in systems with copper tubing. This doesn't happen if oil is used as the fluid in the system—only with water or solutions of water and glycol. This indicates that the aluminum absorbers are acting as a sacrificial anode.

One thing I've noticed over the years is the premature failure of tanks with internal heat exchangers. These include stone lined tanks that are the top of the line in tank quality. Why, we asked for many years? My educated guess is that the accelerated anode corrosion occurs because of the copper heat exchanger's placement, which is right in the middle of the tank. With this in mind, those with internal heat exchange tanks may want to be a little more vigilant in monitoring the solar storage tank's anode rod.

Worth the Cost

Hiring a plumber or solar professional to replace the anode rod might cost you from US\$150 to as much as \$400. To do it yourself, the anode rod will be US\$20 to \$50, and the bloody knuckles if the wrench slips—priceless.

Renewable energy users are looking for long-term, sustainable systems. Regular replacement of anode rods are a great idea to make tanks last longer. Keep your rod in good condition and it will prolong the life of your hot water tank.

Access

Chuck Marken, AAA Solar Supply Inc., 2021 Zearing NW, Albuquerque, NM 87104 • 800-245-0311 or 505-243-4900 • Fax: 505-243-0885 • info@aaasolar.com • www.aaasolar.com

"Water Heater Maintenance—Another Way to Save Energy," by Larry and Suzanne Weingarten in *HP45*



renewable energy & sustainable living fair

renew your life

June 17-19, 2005

central wisconsin

with hundreds of workshops, exhibitors, and displays of renewable energy & sustainable living, the fair is a haven for like-minded people interested in preserving the earth.

the fair is a family friendly event with activities for all ages. come renew your life with our great entertainment, organic food, and inspirational speakers.

sponsors:
alliant energy
focus on energy
home power magazine
kyocera solar, inc
we energies

for more information:
midwest renewable
energy association
(715) 592-6595
info@the-mrea.org
www.the-mrea.org



Chuck knows his . . .

SUNFESTIVAL EVENT BID: 1015
CHUCK SKIDMORE
CITY OF SCOTTSDALE
ENERGY MANAGEMENT ENGINEER

star power!

When he's not helping the city save energy, he's assisting individuals and groups with solar and renewable energy systems for their businesses and homes. He should know, he's been solar at home for 26 years. Way to go, Chuck!

How will you use *your* star power?

Harnessing the sun, wind and water is easier and more affordable than ever!

Join us for Arizona's premier event celebrating, generating and demonstrating renewable energy and healthy living.*

PHOTO: ROBERT SMITH WWW.RSDIGITALART.UNIMSTORES.COM

Sun festival

SECOND ANNUAL

SOUTHWEST

WestWorld / Scottsdale Arizona

WWW.SUNFESTIVAL.NET

great **shopping**
informative **workshops**
world-class **speakers**
kids' **play village**
live **entertainment**
fine **food** and **drink**

April 30
2005 May 1

928.649.8180

SPONSOR • EXHIBIT • VOLUNTEER



McDowell Mountain Music Festival

Held the same weekend at WestWorld

www.mmmf.net



CITY OF SCOTTSDALE: GREEN BUILDING PROGRAM & ENVIRONMENTAL QUALITY BOARD IN HOUSE TICKETING

©2005 Sun Festival Southwest. *Solar panel sunglasses may be a swell idea, but looking directly at the sun is not. Don't try this at home (or anywhere else for that matter).

Powered by Renewable Energy
Fueled by a Passion for Sustainable Living

Natural
Style
A Sustainable Living Festival

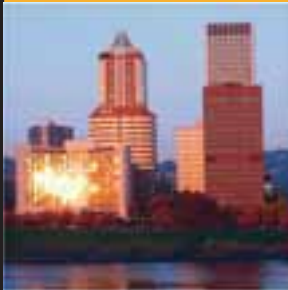

green building & remodeling : sustainable home & garden : solar, wind & green power organic food, beer & wine : bio-fuels & alternative transportation : outdoor recreation & eco-travel : socially responsible investing natural health & wellness : natural fibers & eco-fashion : fair trade & local artisan goods speakers : entertainment : booths : exhibits Oregon Convention Center : info 503-231-4848

May 14-15, 2005
Portland, Oregon
naturalstylefestival.com

7th
Annual

Powering "The Good Life" with Renewable Energy



Over 50 exhibit booths and 50 workshops included with fair entry!

Your Energy Fair for the Northwest and Inland West!

Sponsored By:



July 29-30-31, 2005
Grant County Fairgrounds
John Day, OR

for more information contact: SolWest/EORenew, PO Box 485, Canyon City, OR 97820
541-575-3633, email: info@solwest.org, website: www.solwest.org

EV Range

How Much Is Enough?



Courtesy David Emrich

Shari Prange

©2005 Shari Prange

When someone asks me to recommend a system for an electric vehicle (EV) conversion, my first question is, “How much range do you need?”

A common first answer is, “One hundred miles.” With the ideal combination of chassis, drive system, and driving conditions, you *can* get this range, but it is rare to find yourself in that best-case scenario. And unless you’re willing to spend really big bucks on experimental batteries, achieving that kind of range is unlikely.

A typical EV conversion can deliver a reliable 40 to 60 miles (64–97 km) of range. Heavier conversions, like pickups, may have less, and lighter hatchbacks might have more. Your car may be too heavy, the terrain too hilly, or climate too cold, which all reduce your daily driving range. But don’t give up! Let’s see if you even *need* that much range in the first place. Avoiding two basic mistakes will help you make the most out of an EV with a much lower range than 100 miles (161 km).

All Charged Up

The first mistake many people make with EVs is considering charging in the same way they think of pumping gas. Most of us drive our cars for several days until they are almost on “empty” and then fill them up. But EVs, which rely on battery banks for their power, require a different strategy.

Charge an electric car every night, even if you’ve only used a quarter of its capacity. This keeps the batteries healthy. Batteries don’t like to sit partially discharged, and will lose capacity. When a battery sits dormant, it will self-discharge. And the lower the state of charge is to start with, the faster the self-discharge. So while a fully charged pack will only self-discharge a small amount if you leave it unplugged overnight, a pack that has already partially discharged will self-discharge much more.

In addition to decreasing your EV’s available range, this also shortens battery life. Self-discharging causes sulfation, in which crystals build up on the active battery material, making it more difficult for the chemical reaction that stores and delivers energy to occur. Charging helps knock these crystals loose so they can dissolve back into the electrolyte. The longer the self-discharging occurs, the larger the crystals grow, and the more difficult they are to knock loose. Eventually, too much sulfation will interfere with the battery’s ability to take and give up charge.

If your EV has a 60-mile capacity, and you drive it 10 miles (16 km) a day without recharging, by the third or fourth day, your batteries will be running out of juice. But if you charge it every night, within a few days, the batteries will be restored to their maximum capacity, enabling you to drive 60 miles in one day if you need to.

Charging an EV is much easier and more convenient than pumping gas—just make it a habit to park and plug in the EV every evening. In the morning, unplug and hit the highway. You’ll keep your batteries happy, and get the maximum available range out of your EV every day.

Think Globally, Drive Locally

The next mistake many folks make is assuming that one car should meet all of their transportation needs. Do you really drive 100 miles a day in the same car? Keep a mileage log for a month, and you might be surprised at what you learn.

Most cars in this country are driven 25 miles or less in a day, and most households have more than one vehicle. Could the EV be used for local driving, and your other car for longer excursions? If your household is strictly a one-car family, and if longer trips are infrequent, consider renting a vehicle for those occasions, rather than trying to design your EV with long-range trips in mind.

Quick Tips for Longer Trips

Paying attention to your driving habits—and adjusting them appropriately—also can help maximize your EV's range. Here are some suggestions:

- For cars with manual transmissions, choose the most efficient gear for your speed. You can determine this by watching your ammeter. Electric motors are most efficient at high rpm. This means, for example, that the EV draws fewer amps (and is more efficient) at 40 mph in second gear than in third.
- For cars lacking regenerative braking, minimize braking and maximize coasting. An EV will coast freely for a surprisingly long distance with very little loss of speed. So when you see the light change a block ahead, lift off the throttle and coast. On the freeway, watch traffic flow far ahead and gauge your speed accordingly. Coast down hills, and use the built-up momentum to carry you well up the next hill.
- Keep the EV in good repair. Maintain your tire pressure at the tires' maximum rating, make sure the wheels are aligned, and keep the brakes and wheel bearings in good condition.

If you have a long commute (40 miles or more, one way) each day, and still want to go electric with a little safety margin, investigate your options for plugging in your EV at work. All you need is access to an ordinary 120-volt outlet. It's best if this is a 20-amp outlet with no other loads on it, but even 10 or 15 amps would give your EV a substantial charge by the end of the day. By the time you head home, your batteries will have most of their charge restored.

Reviewing your automobile use and how cars fit in with your daily routine can clarify whether an EV is the most appropriate choice for all of your needs. When using an EV is the right choice, then changing your driving and refueling habits can make a big difference in your range. Once you've dealt with these common errors, then you can decide, "How much range does your EV really need?"

Access

Shari Prange, Electro Automotive, PO Box 1113-HP, Felton, CA 95018-1113 • 831-429-1989 • Fax: 831-429-1907 • electro@cruzio.com • www.electroauto.com



KTA SERVICES INC.

Electric Vehicle Components & Systems Since 1984

Components, Conversion Kits, Publications, Videos, & Engineering Design Services for the EV Hobbyist & Manufacturer

We stock and sell the largest variety of the very best.

Components & Publications Catalog.....\$5.00

944 West 21st Street, Upland, CA 91784 USA

Tel: (909) 949-7914 • FAX: (909) 949-7916 • Web: www.kta-ev.com

A Clean and Quiet Revolution

Enjoy the freedom of driving electric. Join the EAA today and declare your independence from high gas prices and imported oil.



For more information visit us at <http://eaaev.org>

AC Propulsion tzero

ELECTRIC AUTO ASSOCIATION



ELECTRIC

Clean Silent Powerful

ELECTRIC TRACTOR

Things That Work
Makes Work Fun !

14.7:1 stump-pulling rear end electric motor - max torque at zero RPM



Greg of Brooks Solar, Chelan Wash.



See our new webpage about **SOLAR CHARGING GORILLAS** and other Electric Vehicles

ELECTRIC ATV

- Farm / Ranch / Parks
- Tow, Haul, Plow, Mow
- Stealth Security Patrols
- Just Gettin' Around



Mauro the Mountainman near Redding Calif.

info@GorillaVehicles.com
PLEASE SEE OUR WEBSITE
or call for a brochure package:

Gorilla Vehicles
5672 Littler Drive
Huntington Beach, CA 92649
(714) 377-7776

www.GorillaVehicles.com

SOLARFEST 2005

The New England Renewable Energy Festival

July 16 & 17, 2005
Forget-Me-Not Farm, Tinmouth VT

2 Days of Music
On Solar Powered Stages
Vendors of Alternative
Energy Products



Photovoltaic,
Alternative Energy
and Sustainability
Workshops

Exhibitor Space
Available

www.solarfest.org
603-847-9049

Earthwood BUILDING SCHOOL

As a leader in Cordwood
Masonry & Underground
Housing, we've taught
workshops on these subjects
at our off-the-grid campus
since 1981. Since 2000, we've
added workshops in Megalithic
Building and Timber Framing
for the Rest of Us. We also
provide books and videos about
these (and related) subjects.
For our 2005 Schedule and
Book List, contact:

Rob or Jaki Roy
366 Murtagh Hill Road
West Chazy, NY 12992

Tel: 518-493-7744
Email: robandjaki@yahoo.com
Web: www.cordwoodmasonry.com and www.bigstones.com



ELECTRO AUTOMOTIVE

Electric Car Conversions Since 1979

Books ⚡ Videos ⚡ Kits ⚡ Components

- ⚡ **Catalog** Send \$6.00 for our catalog, or visit our web site.
- ⚡ **"Convert It"** We wrote the book on electric car conversions - literally! Send \$30.00 postage paid for this hands-on how-to conversion manual, written in plain English for the home hobbyist mechanic.
- ⚡ **Conversion Kits** Complete custom bolt-in kits for the VW Rabbit and Porsche 914, or a universal kit for other small cars and light trucks.
- ⚡ **Web Site** Visit our web site for our complete catalog, price list, gallery of conversions, and extensive conversion information section.

P.O. Box 1113-HP, Felton, CA 95018-1113 ⚡ 831-429-1989
WWW.ELECTROAUTO.COM ⚡ ELECTRO@CRUZIO.COM

HYDROSCREEN CO. LLC

- **Self Cleaning**
- **Easy Installation**
- **High Capacity**
- **No moving parts**
- **Pipe, ramp and box mountings**

**Precision Wedge Wire
Coanda Screens**
for Hydro, Agricultural, and
Domestic Diversions from
10 gpm to 500 cfs

- We specialize in creatively engineering solutions for your unique hydro diversion screening needs.
- Our solutions are cost effective with numerous screen mounting options; we also have durable 304 SS mounting boxes.

Visit us at www.hydroscreen.com or
call (303) 333-6071
e-mail: RKWEIR@AOL.COM
Mention this ad for special savings!



BZ Products Model MPPT500

Voltage Converting 500 watt 38 amp
MPPT Charge Controller

- Boost charge current up to 30% 15% boost typical.
- Up to 38 amps output current
- 95 % efficiency
- 500 watt PV input
- Universal PV input 12 to 48 volts
- Selectable 12, 24 or 48 volt output
- Digital metering
- PWM float control
- Battery temperature sensor standard
- Optional remote metering
- Five year warranty
- Available world wide
- Patent pending



BZ Products, Inc.



314-644-2490 • www.bzproducts.net • bzp@bzproducts.net
7614 Marion Ct., St. Louis, MO 63143, USA

INCREASE YOUR SOLAR OUTPUT

With Solar Boost™ Maximum Power Point Tracking (MPPT) charge regulators
Patented technology extracts more power from the PV array – up to 30% more!
Reasonably priced and Quality built. Available in a variety of sizes.

Blue Sky Energy, Inc. (formerly RV Power Products) manufactures
and distributes worldwide. We have been producing quality product since 1993.

Contact us today for more information.
Visit our web site www.blueskyenergyinc.com
or email to: sales@blueskyenergyinc.com
800-493-7877 or 760-597-1642 • Fax 760-597-1731
2598 Fortune Way, Suite K, Vista, CA 92081 USA



Blue Sky
ENERGY

SOLARTRAX™ POWER STATIONS

The 200 Series
Solar Power Tracking Stations



for Residential and Remote Applications

Official Distributor of:

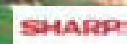

www.solartrax.com 619 Commercial Ave. Covina, California 91723 Phone 626 331-9570 Fax 626 331-8584

Checklist

For Designing & Installing a PV System

John Wiles

Sponsored by the Photovoltaic Systems Assistance Center,
Sandia National Laboratories

Planning a PV system? The checklist below, while not all-inclusive, lists items that should go into the planning and design process. It is similar to a checklist that is used by some electrical inspectors when inspecting PV systems. References to the *National Electrical Code (NEC)* are presented in brackets so you can look at the actual code requirements. Detailed explanations can be found at the Southwest Technology Development Institute Web site (see Access) where you can download past *Code Corner* columns.

Installation Checklist

PV Array

- Are the PV modules listed to UL Standard 1703? [110.3]
- Are the modules attached to the mounting structure according to the manufacturer's instructions?
- Are roof penetrations for mounts secure and weathertight?
- Is each module grounded using the supplied hardware, the grounding point identified on the module, and the manufacturer's instructions?

Note: The installer must always use the hardware and instructions supplied with the module except when that hardware or the instructions are inadequate or do not meet the requirements or intent of the code. In addition, bolting the module to a "grounded" structure usually will not meet NEC requirements.

- Are equipment-grounding conductors routed with the circuit conductors?
- Are the equipment-grounding conductors properly sized? [690.45]
- Has the correct PV array conductor type been used? If exposed, types USE-2, UF (usually inadequate at 60°C; 140°F), or SE may be used. They must be rated for 90°C (194°F), wet-rated, and sunlight-resistant. [690.31(B)]. If in conduit, types RHW-2, THWN-2, or XHHW-2 may be used. They must be rated for 90°C, and be wet-rated conductors. [310.15]
- Is the PV array conductor insulation rated at 90°C (194°F) [UL-1703] to allow for operation at 70°C (158°F) or higher, near modules and in conduit exposed to sunlight?
- Were temperature-derated ampacity calculations, based on 156 percent of short-circuit current (I_{sc}), used? [690.8]

Note: A temperature derating factor of 65°C (149°F) is suggested in installations where the backs of the module receive cooling air (mounted 6 inches or more from the mounting surface) and a derating factor of 75°C (167°F) is recommended where little or no cooling air can get to the backs of the modules. Ambient temperatures in excess of 40°C (104°F) may require different derating factors.

- Is the derated ampacity for the PV array conductors greater than the rating of any overcurrent device (156 percent I_{sc})? [690.9]
- Were portable power cords used only for tracker connections? [690.31(C), 400.3,7,8]
- Were strain reliefs/cable clamps or conduit used on all cables and cords, and are they listed for the application and the environment? [300.4, 400.10]

Overcurrent Protection

- Are all overcurrent devices in the DC circuits listed for DC operation? If a device is not marked DC, verify its DC listing with the manufacturer. Auto, marine, and telecom devices are not acceptable.
- Has overcurrent protection been rated at 1.56 times (1.25 x 1.25) the short-circuit current from modules? [UL-1703, 690.8, module instructions]

Note: Both 125 percent factors are now in the NEC. Supplementary listed devices are allowed in PV source circuits only, but branch-circuit rated devices are preferred. [690.9(C)]

- Does each module or series string of modules have an overcurrent device protecting the module or string? [UL-1703/NEC 110.3(B)]
- Note: Frequently, installers ignore this requirement, which is marked on the back of modules. Listed PV combiner boxes meeting this requirement are available. SMA Sunny Boy and some other "string" inverters may not require DC fuses with two strings of modules or fewer.*
- Are overcurrent devices located in a position in the circuit to protect the module conductors from backfed currents from parallel module circuits or from the charge controller or battery? [690-9(A) FPN]
- Is the smallest conductor used to wire modules protected? Sources of overcurrent are parallel-connected modules, batteries, and AC backfed through inverters. [690-9(A)]
- Are user-accessible fuses in "touch-safe" holders or capable of being changed without touching live contacts? [690.16]

Electrical Connections

- Have pressure terminals been tightened to the recommended torque specification?
- Are crimp-on terminals listed and were they installed with listed crimping tools by the same manufacturer?
- Are twist-on wire connectors listed for the environment (dry, damp, wet, or direct burial) and were they installed per the manufacturer's instructions?
- Are pressure lugs or other terminals listed for the environment (inside, outside, wet, direct burial)?
- Are power splicing blocks listed, and not just UL recognized?
- Are terminals containing more than one conductor listed for multiple conductors?
- Are connectors or terminals using flexible, fine-stranded conductors listed for use with such conductors?

Charge Controllers

- Is the charge controller listed to UL Standard 1741? [110.3]
- Are energized terminals readily accessible?
- If the charge controller is a diversion controller, does the system have an independent backup control method? [690.72(B)(1)]

Disconnects

- Are all disconnects in DC circuits listed for DC operation? Automotive, marine, and telecom devices are not acceptable.
- Are PV disconnects readily accessible and located at first point of penetration of PV conductors? [100, Definitions: Accessible, Readily & 690.14(C)(1)]
- Are PV conductors kept outside of the structure until reaching the first readily accessible disconnect, unless in a metallic raceway? [690.14, 690.31(F)]
- Are there disconnects for all current-carrying conductors of PV source? [690.13]
- Are there disconnects for equipment? [690.17]
- Are grounded conductors *not* fused or switched? Bolted disconnects are OK.

Note: Listed PV Centers by Xantrex, OutBack, and others for 12-, 24-, and 48-volt systems contain charge controllers, disconnects, and overcurrent protection for the entire DC system, with the possible exception of module-protective fuses.

Inverters (Stand-Alone Systems)

- Is the inverter listed to UL Standard 1741? [110.3]
Note: Inverters listed to telecommunications or other standards do not meet NEC requirements.
- Have DC input currents been calculated for cable and fuse requirements? Input current equals the rated AC output in watts, divided by lowest battery voltage, divided by inverter efficiency at that power level. [690.8(B)(4)]
- Are cables to the batteries sized at 125 percent of calculated inverter input currents? [690.8(A)]
- Are overcurrent/disconnects mounted near the batteries and external to PV load centers if the cables are longer

than 4 to 5 feet (1.2–1.5 m) to the batteries or the inverter?

- Have high interrupt, listed, DC-rated fuses or circuit breakers been used in battery circuits? Is the amps interrupt rating (AIR; usually applied to fuses) or the amps interrupt capability (AIC; usually applied to circuit breakers) at least 20,000 amps? [690.71(C), 110.9]
- Have multiwire branch circuits been eliminated when single, 120-volt inverters are connected to 120/240-volt load centers? [100–Branch Circuit, Multiwire], [690.10(C)]

Note: A multiwire branch circuit is a three-wire circuit with a shared neutral for two, 120-volt branch circuits.

Batteries

Note: No batteries are UL listed.

- Have building-wire-type cables such as USE, RHW, and THW been used? [Chapter 3; see Table 310.13 for a complete list.]

Note: Welding cables, marine, locomotive (DLO), and auto battery cables don't meet NEC requirements. Flexible, Article 400 cables (in sizes #2/0; 67 mm² and greater) and flexible RHW or THW cables are available, but these cables require very limited, specially listed terminals. When the battery conductors leave the battery enclosure, the conductors must be of a type listed for use in conduit (RHW or THW)—Article 400 cables are not. [690.74, 400.8] See Inverters (Stand-Alone Systems) for ampacity calculations.

- Is access to the batteries limited? [690.71(B)]
- Are batteries installed in well-vented areas (garages, basements, outbuildings, and not living areas)?
Note: Manifolds, power venting, and single exterior vents to the outside are not required.
- Are cables to inverters, DC load centers, and/or charge controllers in conduit? [300.4]
- Does conduit enter the battery enclosure below the tops of the batteries?

Note: There are no listed battery boxes. Lockable, heavy-duty plastic polyethylene toolboxes are usually acceptable.

Inverters (Utility-Interactive Systems)

- Is the inverter listed to UL Standard 1741 and identified for use in interactive photovoltaic systems? [690.4(D), 690.60]
Note: Inverters listed to telecommunications and other standards do not meet NEC requirements.
- Is there a charge controller to regulate the batteries (if present) when the grid fails? [690.72(B)(1)]
- Is the inverter connected to a dedicated branch circuit with backfed overcurrent protection? [690.64]
- Have listed DC and AC disconnects and overcurrent protection been used? [690.15,17]
- Is the total rating of the overcurrent devices *supplying* electricity to the AC load center (main breaker plus backfed PV breaker) less than the load center's rating (120 percent of the load center's rating in residences)? [690.64(B)(2)].

Grounding

- Has only one bonding conductor (grounded conductor to ground) for DC circuits and one bonding conductor for AC circuits (neutral to ground) been used for system grounding? [250]
Note: The DC bonds may be located inside inverters or in ground-fault protection devices.
- Are AC and DC grounding electrode conductors connected properly? They may be connected to the same grounding electrode system (ground rod). Separate electrodes, if used, must be bonded together. [690.41,47]
- Are equipment grounds properly sized (even on ungrounded, low-voltage systems)? [690.43]
- Have disconnects and overcurrent devices been used in both of the ungrounded conductors in each circuit on 12-volt, ungrounded systems? [240.20(A)], [690.41]
- For inverters with a system voltage more than 250 VDC, were bonding fittings used if metal conduits were used? [250.97]

Conductors (General)

- Were standard building-wire cables and wiring methods used? [300.1(A)]
- Were wet-rated conductors used in conduits in exposed locations? [100 Definition of Location, Wet]
- Are the DC color codes correct? They are the same as AC color codes—grounded conductors are white and equipment-grounding conductors are green, green/yellow, or bare. [200.6(A)]

Summary

This checklist is not intended to replace a working knowledge of the code. If you are contemplating designing and installing a PV system, by all means, get a copy of the current edition of the *National Electrical Code* for your area. Some parts of the country are still using the 1999 and 2002 editions of the *NEC*.

Access

John C. Wiles, Southwest Technology Development Institute, New Mexico State University, Box 30,001/MSC 3 SOLAR, Las Cruces, NM 88003 • 505-646-6105 • Fax: 505-646-3841 • jwiles@nmsu.edu • www.nmsu.edu/~tdi/

Sponsor: Sandia National Laboratories, Ward Bower, Department 6218, MS 0753, Albuquerque, NM 87185 • 505-844-5206 • Fax: 505-844-6541 • wibower@sandia.gov • www.sandia.gov/pv

The 2005 *NEC* and the *NEC Handbook* are available from the National Fire Protection Association (NFPA), 11 Tracy Dr., Avon, MA 02322 • 800-344-3555 or 508-895-8300 • Fax: 800-593-6372 or 508-895-8301 • custserv@nfpa.org • www.nfpa.org



North American Board of
NABCEP
Certified Energy Practitioners

**NABCEP Solar PV
Installer Certification**

Why PV Installers Should Get Certified

- Certification based on industry standards of safety
- Distinguishes you among your peers
- More consumers look for certification as a sign of competence and quality
- Helps you keep current in technology and continue your professional development

Consumer Benefits of Using
NABCEP-Certified PV Installers

- Provides confidence that PV system will be installed to manufacturer's specs and in compliance with NEC
- NABCEP Code of Ethics stresses consumer protection, professional conduct and integrity of service
- The installer has met established PV standards and industry requirements through certification process, and keeps current through continuing education

For more information to www.nabcep.org

Things that Work!
Model 4-1850
Home Power #67



Digital Power Meters

20-CTR: Measures AC Power up to 10 kW, 100-250 vac single or two phase. Remote display. Easy to install.

ONEMeter: NEW FEATURES! Standard Features include Multiple AC or DC power channels (any voltage/current), PC interface (with PC software), internal logging, and one display. Options now include Flash Memory Logging (up to 1 Gig!), USB connection, simple Web interface, extra displays (many types/sizes), Battery Monitor, Weather Monitoring (wind speed, direction, temperature, humidity, solar output) and Control output. The OneMeter can be field upgraded with new hardware/firmware.

4-1850WX: Special meter for Refrigerator Replacement Programs. Detects Defrost Cycle, displays cost/kWh-hrs/yr. Other Models available. Check our website or call for details.

All products are California CEC eligible meters

CUSTOM APPLICATIONS and DISPLAY OPTIONS: We can build a digital power meter to meet your needs, including large displays as well as the popular Beta Brite scrolling LED sign. Please call with your needs/ideas.

Brand Electronics
421 Hilton Rd.
Whitefield, ME 04353
For information only, call 207-549-3401
info@brandelectronics.com

To order, call toll free
1-888-433-6600
www.brandelectronics.com

Cut Your Own Lumber!

**Fast!
Easy!
Portable!
Profitable!**

Call for a FREE Brochure and Video!



See it in action on our website!

The Ultimate Portable Saw Mill

Logs To Lumber - On The Spot!

© 2005 Bailey's Inc.

Bailey's Est. 1975

The World's Largest Mail Order Woodsman Supplies Company - Selling at Discounted Prices.

Call today and mention source code: **H7Q5** for your **FREE 2005 Master Catalog, Video and Brochure!**

TOLL FREE 1-800-322-4539 TOLL FREE
www.baileys-online.com

Canyon Industries, Inc.
PO Box 36
Dorling, WA 98244



Pelton and Crossflow Turbines

Canyon 1215-2

COMPLETE STAND ALONE HYDROELECTRIC POWER SYSTEMS



TYPICAL PELTON INSTALLATION

phone: (360) 592-5552
fax: (360) 592-2235
www.canyonhydro.com
please contact us for your free brochure

- Manufacturing Turbines Since 1976 -

ZOMEWORKS CORPORATION
RELIABLE PASSIVE ENERGY PRODUCTS SINCE 1969

NEW TO THE ZOMEWORKS FAMILY OF TRACKERS: THE UTRK040

Improvements from UTR040 include:

- Light weight for quick installation
- Early morning wake-up fin for fast response
- Dual shock absorbers for better stability
- Accommodates odd numbers of modules
- Ships partially assembled via UPS

The UTRK040 fits on a 3" (3-1/2" OD) Schedule 40 Steel Pipe
The UTRK040 will replace the UTR040
The UTR040 will no longer be available after January 1, 2005

All UTRK040 photos taken by Total Light & Power



UTR040 photo by Southwest Texas Solar



UTR040 installation by Total Light & Power took less than 1-1/2 hours to install which was less time than it took to mount the modules.



UTR040 not shown



UTR040 photo by Tacx Green Solar



UTR040 photo by Renewable Energy Concepts



UTR040 in Zomeworks yard

Don't forget we also have a full line of competitively priced fixed racks.

Also check out our website for information regarding Cool Cells and architectural heating and cooling with Zomeworks Double Play Systems.

New updates to our website coming soon!

ZOMEWORKS CORPORATION
PO BOX 25805
ALBUQUERQUE, NM 87125
PHONE: 800-279-6342 / 505-242-5354
FAX: 505-243-5187
EMAIL: ZOMEWORK@ZOMEWORKS.COM
WEBSITE: WWW.ZOMEWORKS.COM

RE Expos & Education

for Professionals

Don Loweberg

©2005 Don Loweberg

Today, a highly qualified RE-installing dealer base exists here in the United States. RE equipment manufacturers have long been providing training workshops at various locations across the country. But the new trend of comprehensive, distributor-organized, professional training events will be a key component in advancing the design and installation skills of current installers, and helpful in training licensed electricians who are stepping into the renewable energy field.

In-depth workshops presented directly by equipment manufacturers are invaluable, and distributor-hosted training events that include multiple manufacturers will certainly draw more installing dealers. The designs that equipment installers use are dynamic and always evolving, and training opportunities are crucial to the expansion of the RE industry.

PV in the Sleepless City

Energy Outfitters, an Oregon-based RE distributor and original equipment manufacturer, hosted their second annual RE Dealer/Installer Tech Expo last December at Caesars Palace, on the Strip in Las Vegas. This location provided lodging for attendees, a ballroom for the manufacturers' display booths, meeting rooms for classes and workshops, and numerous restaurants and entertainment venues. It was very convenient having everything in one location, though somewhat disconcerting to realize you could spend days here without going outside.

Holding an RE event in Las Vegas presents a quizzical juxtaposition between the vision of a renewable energy future and one of the country's grandest displays of extravagance and waste. Vegas is not without its incongruous moments.

Four days were devoted to RE workshops, trainings, and social events. Participants could choose from 23 different workshops, ranging from PV mounting solutions



Courtesy of David Emrich

Renewable energy comes to Vegas—one Expo at a time.

to site safety. The recurrent scheduling of these hour-long workshops over a period of three days allowed participants to attend all presentations of interest. On the last day, in-depth training sessions were offered, some of which satisfied the North American Board of Certified Energy Practitioners' (NABCEP) continuing education requirements.

New to the Field

The Energy Outfitters Expo workshops emphasized technical content with a focus on information valuable to installer-dealers. Several new companies and products also caught my eye. Here's a sampling:

PV in the Round. A PV technology that has been in development for a number of years uses microbeads of silicon as the generating cell. Originally, Southern California Edison (a large California utility) owned the patents for this technology. Now, Spheral Solar Power (SSP), a Canadian company, holds the patents. I spoke with Don Campbell, SSP sales manager, and learned the following about SSP's PV product.



From left to right: Bob Maynard of Energy Outfitters, and Bob and Robin Gudgel of OutBack Power Systems.

Each tiny silicon bead, a fraction of a millimeter in diameter, is a complete solar cell. Millions of these beads are bonded to a thin, metallic foil that provides electrical connection and mechanical support for each of the tiny cells. Once bonded and sealed, the resulting sheet, or "macro cell," can be assembled into modules or other products. The finished appearance is very similar to a standard PV module.

Conventional crystalline silicon cells must be sliced from an ingot. In that process, a fair amount of silicon ends up as waste. Even when the wafers are cut as thinly as possible, more silicon is used than is necessary to produce the PV effect. The PV effect occurs at the surface of the silicon material; most of the light energy is absorbed within the first few atomic layers. The remaining mass of silicon functions simply as a conductor for the freed electrons.

Modules made using the spherul process use much less silicon and produce less waste. If spherul-cell output efficiency (currently about 10 percent) can approach that achieved using wafer technology, and automated production methods can produce finished modules at a competitive price, SSP could be a new player in the module market.

Improving Performance. Apollo Solar and PV Powered, two new inverter companies, are offering ten-year warranties on their grid-tie inverters. A few years ago, only two- and five-year warranties were available for inverters.

Apollo Solar's 2800UI ecoJoule grid-tie inverter is a lightweight, 2,800-watt inverter boasting extensively metered output and 93 percent efficiency. It's expected to hit the market soon.

PV Powered also warrants their StarInverters for ten years. These inverters are available for shipment now; a good number of them are already in service. Anecdotal feedback from the field gives the StarInverter high marks. The StarInverter's published specifications are notable. In addition to the ten-year warranty, the inverters operate at efficiencies greater than 95 percent and maintain full output at high ambient temperatures. The StarInverter's

performance at high temperatures is notable because it is achieved without using a fan. PV Powered claims that the inverters' high performance and reliability are the result of a design that minimizes the number of components.

Watt's Happening? Fundamentally, customers need to know how their systems are performing; many inverters provide onboard metering and digital data output. The digital output can be logged locally and displayed on a PC, giving an owner a historical view of their system's performance. It is also possible to log and store system performance nonlocally, for example on a Web site. Currently, Web-based monitoring is used to share site data from PV users. This technology is particularly appropriate for PV-powered schools and businesses that wish to showcase their RE systems' production capabilities.

As distributed PV continues to penetrate the utility system, additional needs and opportunities arise for Web-based system monitoring. And that's precisely where Fat Spaniel Technologies' PV2Web comes into play.

In addition to being compatible with the data output provided by most grid-tie inverters, PV2Web also can gather its own data using discreet input sensors. The PV2Web product consists of hardware components (data modules, wiring harnesses, enclosures), software that provides various display options, and a Fat Spaniel Web-hosting service.

User site data is logged directly to the Fat Spaniel Web site; authorized users can then access the data via the Web. Potential users include system owners interested in knowing and sharing their system's performance data, or system installers who may monitor their customers' systems as part of a service program.

Another application of Web monitoring could involve third-party financial transactions, such as the accounting and sale of renewable energy credits. With Web-based accounting and management, even small transactions can be conducted securely and affordably.

A Solar Success

The Energy Outfitters' Expo was a success. Keeping the size modest (at about 250 attendees), and the information focused on the needs of the dealer-installer maximized its

Isotofón meets BP Solar.



independent power providers

value. Not only did the Expo offer a showcase for new products, trainings, and workshops, but it also provided a setting for attendees to rekindle old relationships, make new friends, and trade stories and information.

Access

Don Loweburg, PO Box 231, North Fork, CA 93643 • 559-877-7080 • Fax: 559-877-2980 • i2p@aol.com

Apollo Solar, 23 F.J. Clarke Cir., Bethel, CT 06801 • 203-790-6400 • Fax: 203-792-0399 • davidf@apollo-solar.net • www.apollo-solar.net • ecoJoule 2500UI inverter

Fat Spaniel Technologies Inc., 2 W. Santa Clara St. 5th Floor, San Jose, CA 95113 • 408-279-5262 • Fax: 408-516-9111 • info@fatspaniel.com • www.fatspaniel.com • PV2Web software and user interface

PV Powered LLC, 160 SW Scalehouse Loop #208, Bend, OR 97702 • 877-312-3832 or 541-312-3832 • Fax: 541-383-2348 • info@pvpowered.com • www.pvpowered.com • StarInverters

Spherical Solar Power, 25 Reuter Dr., Cambridge, ON, Canada N3E 1A9 • 519-653-6500 • Fax: 519-650-6519 • info@spheralsolar.com • www.spheralsolar.com • Spherical-cell (microbead silicon) PV modules

Other companies at the Expo included: Alpha Technologies, Alternative Power & Machine, Array Technologies, Blue Sky Energy, BP Solar, CAP Solar, DP&W Power-Fab, Fronius USA, GE Energy, Grundfos USA, Harris Hydro, Isofotón-North America, Magnetek, MK Battery, Morningstar Corp., NABCEP, OutBack Power Systems, ReadyWatt, RenewableEnergyAccess.com, Southwest Windpower, SunLink Solar, Surette Battery Co., Sutton Solar Services, Trojan Battery Co., UniRac Inc., Uni-Solar, and Xantrex.



SoL is "Solar-on-Line"

Internet-based Distance Courses with practical skills workshops



Internet-based distance courses year-round
Practical skills workshops offered in the US and Mexico
Visit the Solar-On-Line website for schedule and details

For current schedule of On-line Courses & Workshops
Click on SoL www.solar-on-line.org

E-mail: SoL@SoEnergy.org • Phone/Fax: 720-489-3798
See Happenings in this issue for the 2004 schedule of courses.

RENEWABLE ENERGY SOLUTIONS!

**WIND POWER
MICROHYDRO
GENERATORS &
ALTERNATORS**



HUMAN POWER GENERATOR

WINDSTREAM POWER SYSTEMS INC.

PO Box 1604 HP, Burlington, VT 05402 Tel 802 658 0075 Fax 802 658 1098
info@windstreampower.com • www.windstreampower.com
Independent Power Systems Throughout the World – Our 29th Year



Independent Energy Systems

Our 21st Year Offgrid!
We provide excellent service & technical support.
Residential Power • Water Systems • Communications
Wind • PV • Hydro • Custom Design • Installation
All Major Brands



Don Loweburg
NABCEP Certified Installer

California Rebates!

OFF LINE

Located in the central Sierra, near Yosemite

e-mail: ofln@aol.com
www.psnw.com/~ofln
P.O. Box 231, North Fork, CA 93643

(559) 877-7080
CA Lic. #661052



2-KS-33P

- Perfect for large off-grid systems
- Voltage: 2V
- Container: Dual-Container, modular construction
- Capacity: 2,470AH (100hr), 1,750AH (20hr)
- Weight: 208 lb Wet, 145 lb Dry
- Dimensions: 24 ¹³/₁₆ H x 13 ³/₄ L x 8 ⁵/₁₆ W
- Warranty: 10 years
- Operational Life: 15-20 years

1-800-681-9914

sales@rollsbattery.com • www.rollsbattery.com



Surrette Battery
Company, Ltd.



Gobi Solar Collector

Sought after for lasting high performance

Check out our easy packages for large or small water, home or pool heating systems



HELIODYNE, INC.

4910 SEAPORT AVE., RICHMOND, CA. 94804
Tel (510) 237-9614, Fax (510) 237-7018
info@heliodyne.com

Get the credit you deserve for caring about the planet at the



Permaculture Credit Union

We are making loans that make a difference to the people who make a difference.

We offer a 0.75% sustainability discount on loans for earth-friendly projects, including:

- Solar heating and electricity systems
- Home energy efficiency upgrades
- Fuel-efficient vehicles
- Efficient windows & insulation
- Rainwater catchment systems

Call us for loan programs and current rates.

(505) 954-3479 or toll-free (866) 954-3479

www.pcuonline.org

4250 Cerrillos Road, P.O. Box 29300

Santa Fe, NM 87592-9300

Do something nice for yourself, your community, and the earth...call the PCU today.

Nuclear Power

Resurgence?

Michael Welch

©2005 Michael Welch

It has been more than 25 years since the nuclear power accident at the Three Mile Island plant near Harrisburg, Pennsylvania. Not a single order for a U.S. nuclear power plant has been placed since then. And it has been 19 years since the meltdown at Chernobyl in western Russia killed more than 100,000 people and created a 36-mile (58 km) wide "dead zone" around the power plant, causing the permanent evacuation of more than 160,000 people. Yet the nuclear industry and its supporting utilities have hope that nuclear power plants will again be sited in the United States.

Unfortunately, a U.S. nuclear resurgence would not just cost tax dollars. It would reduce our right to participate in the plant and site licensing processes as well. The utilities

and the nuclear industry are not interested in spending much of their own money on new nukes. But they are very interested in leveraging small investments in public relations to get more government investment and fewer regulatory restrictions, which might eventually result in new nuclear power plant construction. And the only way to stop it is increased vigilance by U.S. citizens and the public interest organizations that do our bidding.

No More Nuke Plants?

For many years, the public has been quiet on the issue of nuclear energy. The '80s and '90s were full of hope in the oft-heard opinion, "No nuclear power plants will ever be built in the United States again." I was also guilty of this sentiment, which more and more is beginning to look like wishful thinking rather than the reality of the situation. The public has seriously underestimated the staying power and resources of the nuclear industry.

While activists and the public have been sitting back expecting nothing to happen, the industry has been quietly spending money to regain the popularity it enjoyed in the '50s through the early '70s, when industry spokespeople touted nuclear electricity as "too cheap to meter." Relatively small investments in public relations can have a huge effect on public opinion, especially when opponents don't have money to spend on that kind of thing. A single pro-nuclear ad campaign can dwarf the entire annual operating budget of most public interest nonprofits.

The Answer to Our Problems?

Via well-designed public relations campaigns, the nuclear industry has been the biggest beneficiary of the threat of global warming by claiming to be the only viable answer to the problem. They also are claiming that a nuclear resurgence is the best way to increase environmental pressure on the dirty coal plants that are so prevalent in the United States, and the best way for the public to avoid future high electricity prices due to the volatility of natural gas and heating oil prices. Finally, the nuke industry claims to be the best method of hydrogen production for ushering in the so-called "hydrogen economy."

Most U.S. citizens have repeatedly heard these claims in some form or another. Repetition is the basis of modern

The "dead zone" around the Chernobyl nuclear reactor includes several cities that were abandoned soon after the April 1986 accident, and are still unsafe for habitation.



Courtesy of Minsk zoologist Vladimir Bilinov

political and advertising psychology: “If you repeat something often enough and with enough conviction, it becomes the truth.” And watch out for the latest spin coming out of Washington—President Bush is now referring to nuclear power as a “renewable” resource.

In a letter to the President, 48 environmental, business, and energy policy groups have refuted the notion that nuclear energy is “renewable.” On the other hand, Exelon Nuclear Corp. President John Rowe’s response was, “It is always gratifying to have the President on your side.” Exelon has more nuclear capacity than any other utility in the nation, and stands to benefit greatly from government favor.

So far, it has not been enough for the pro-nukers to merely bump the polls a bit toward their industry. They are spending money in other areas to improve the political climate. Support for election campaigns and the use of professional lobbyists in Congress and in the states are the other two sides of the industry’s three-pronged attack.

And it looks like it is paying off. The federal government has been investing in an international initiative to develop a new generation of nuclear power plants, and one “advanced reactor” design was approved last year for possible U.S. use. The Nuclear Regulatory Commission (NRC) continues to streamline the nuke plant application process, including eliminating as much public participation as it can get away with, in hopes of actually getting an application for construction and an operating license some day.

Will the Government Rescue Us?

The Department of Energy (DOE) is giving out funds to utilities and nuclear coalitions for exploration of possible nuclear power plant sites and reactor licensing. For example, a recent article in the *Atlanta Journal-Constitution* announced that the mega-utility Southern Company applied for a US\$245,000 grant to look at sites in its territory. If the money is made available, the utility expects to complete the survey by March 2005, and they will decide within a couple of months whether to apply for an NRC siting permit.

According to the article, Southern Company “joined a consortium of huge energy companies interested in trying out the NRC’s new permitting processes.” The consortium received US\$4 million from the DOE in November. The article revealed that three other nuclear power plant operators, Exelon, Dominion, and Entergy, have each applied for NRC permits to explore specific new plant sites.

I am not aware of recent polls in the United States, but according to the *Times of London*, a new industry poll reported that 30 percent of the British population opposes building new nuke plants, which is down from 60 percent three years ago. About 35 percent said they were favorable towards nuclear energy, up from 19 percent in 2001.

But this poll can be looked at in two opposing ways. First, you might see the increased favor being the result of the nuclear industry’s efforts to gain more acceptance, bolstering the point of this article that the industry is winning the war of words. On the other hand, since the poll was commissioned and the figures announced by the

nuclear industry itself, the figures could be viewed merely as another public relations effort to gain more acceptance and government intervention. In either case, the figures are alarming, though suspect.

What Must We Do?

If we are to keep new plants from being built in the United States, it is critical that we keep the problem in mind. Lack of vigilance is exactly what the nuke industry needs in order to start gearing up again. Vigilance calls for action, and it is up to us to keep the issue in the public eye. Write letters to the editor, and call your federal legislators.

The Nuclear Information and Resource Service (NIRS) urges you to “write your Senators and House member, and tell them—in your own language—that you opposed last year’s energy bill and will oppose any new bill that provides for taxpayer funding of new reactors, or Price-Anderson reauthorization, or name another issue that is important to you. Further, you should tell them that you expect them to oppose such bills, and to do so with all means at their disposal, including filibuster.”

NIRS suggests two important talking points. Nuclear energy should compete on its own merits. If it is not economically viable without taxpayer support, it should not be used. And nuclear energy is not a useful means of addressing global warming—it’s just too expensive. Allocating resources to new nuclear construction means fewer resources are available for technologies that can effectively lessen the environmental impact of energy production.

NIRS also encourages you to sign their online petition at www.nirs.org/petition/index.php. Or you can download it from the Promised Files section of www.homepower.com, gather some signatures, and send it in yourself. The NIRS petition informs Congress that:

1. *Energy efficiency and clean renewable energy must form the basis of a national energy policy;*
2. *Our energy policy should provide funding for twenty-first century energy technologies, such as renewable energy, fuel cells, microturbines, green hydrogen, and other sustainable forms of energy production;*
3. *Our energy policy should simultaneously address and seek to overcome the critical issues of global climate change, radioactive pollution, and resource depletion;*
4. *Our energy policy must provide no funding or other support for nuclear power, which poses national security and safety threats, and causes contamination of our country. Indeed, our energy policy should seek to end further production of radioactive waste as quickly as possible;*
5. *Our energy policy should include increased gasoline mileage standards for vehicles. Oil drilling must not be allowed in the Arctic National Wildlife Refuge.*

Publilius Syrus said, “He is most free from danger, who, even when safe, is on his guard.” We may have been feeling safe from the dangers of more nuclear energy, but in reality, we may be on the verge of a breakthrough in opposition to that safety. We worked hard in the ’70s and

'80s to stop the nuke industry, and it looks like it is time to get fired up again.

Access

Michael Welch, c/o Redwood Alliance, PO Box 293, Arcata, CA 95518 • 707-822-7884 • michael.welch@homepower.com • www.redwoodalliance.org

Nuclear Information & Resource Service (NIRS), 1424 16th St. NW #404, Washington, DC 20036 • 202-328-0002 • Fax: 202-462-2183 • nirsnet@nirs.org • www.nirs.org

Public Citizen's Critical Mass Project, 1600 20th St. NW, Washington, DC 20009 • 202-588-1000 • Fax: 202-547-7392 • cmep@citizen.org • www.citizen.org/cmep





**Shell SQ175-PC
BP 3125
OutBack parts
Custom Cables
Complete Packages - In Stock!
1-800-766-7644**

www.solarpanelstore.com

Look closely...



Accumax, Bergoy Wind Power & Southwest Wind Power Wind Turbines

Starting at \$519

NEW!

Solectria's
New line of
Grid Tie Inverters
Super lightweight
Includes Free digital
display, computer port
for extra data logging.
No heating due to temperature
Made in USA
Starts at \$1729

Great prices, products & service!

Shop at:
www.AltEnergyStore.com/hp
Or call us:
1(877)878-4660 ext. 3



**Alternative Energy
STORE**
Making Renewable Energy Affordable™

Great Prices on 1000's of Products - Free Educational Information - Friendly Service

HASSLE-FREE HYDRO POWER

- RELIABLE
- BRUSHLESS
- BATTERIES OR GRID TIE
- NO MECHANICAL ADJUSTMENT

Head Range: 60' - 500'
Flow Range: 10 - 600gpm
Power Range: 100 - 3600W
Battery Voltage: 12V, 24V, 48V
Transmission Voltage: 120 - 480VAC



~Since 1982~

HYDRO INDUCTION POWER

www.hipowerhydro.com ~ 707-923-3507

Independence, Sustainability, Security

- ◆ Experts in System Design
- ◆ Competitive Pricing
- ◆ Extensive Webstore Selection

Call Toll Free or Visit our Webstore

1-866-765-9463
www.ecoenergies.com





Solar Electric, Wind and BackUp Power Systems

California General Contractor License #723331 ("B"), C-46 (Solar) & HIC

BackHome

MAGAZINE

Your Guide
to Self-Reliant Living

Take control of your own life. Thousands of people have gone BACKHOME to enjoy less complicated, more rewarding lives . . . and you can join them. In each bimonthly issue, find articles on topics such as: Alternative Home-Building Techniques, Organic Gardening, Selecting a Home Business, Living Mortgage Free, and much, much more!





Subscribe to BACKHOME
for just \$21.97 per year.
Call us at 800-992-2546,
write to us at P.O. Box 7011,
Hendersonville, NC 28793
or visit our Web site

www.BackHomeMagazine.com

Intentional Communities



Dedicated to communicating the experience and wisdom of intentional community.

We've been at it for 30 years, and nobody covers the world of community like *Communities* magazine.

1 year subscription \$20 (\$24 Canada)
Sample issue \$6 (\$8)

800-462-8240 fic.ic.org/cmag

SOLAR COOLING

WITH

SOLAR CHILL

ULTRA LOW ENERGY
25 TO 130 WATTS!

The most efficient coolers
on the planet.

12 & 24 Volt DC Evaporative Coolers
KAR KOOL FOR YOUR VEHICLE



Call **SOUTHWEST SOLAR**
(520) 885-7925 Tucson, Arizona, USA
southwest-solar.com

sunelec.com

Worldwide Wholesalers

JohnKimball@sunelec.com

Tel: 305-536-9917

Solar Parts and Systems for the Do-it-yourselfer

Serving North America for 25 years

Online Catalog and Design Guide
www.aaasolar.com

AAA Solar Supply
(800) 245-0311
Albuquerque, NM

Rotor— Wind Collector

Ian Woofenden

©2005 Ian Woofenden

Derivation: Contraction of “rotator” from Latin rota, wheel.

The rotor of a wind generator is the blades and hub—the visible part that rotates. (The moving part of the alternator is also called a rotor, but that’s not what I’m talking about here.) The blades travel around the hub, describing a circle known as the “swept area.” Just as the area of a solar-electric or solar hot water panel is what collects the sun’s energy, the swept area of a wind turbine is its collector.

A wind generator’s blades take the horizontal motion of the wind and translate it into rotary motion to drive the

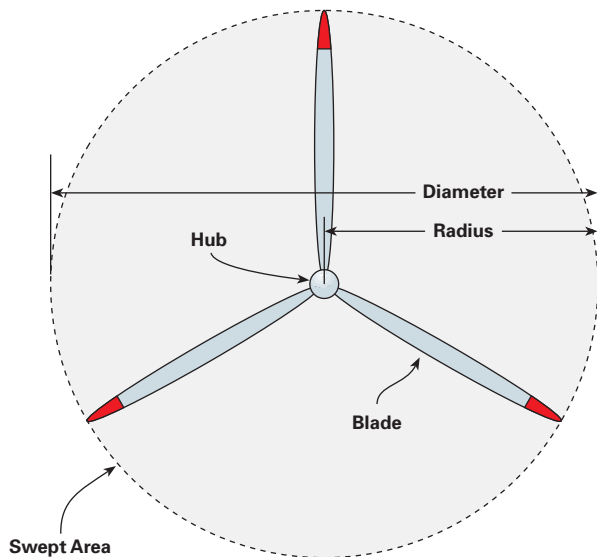

generator. But don’t assume more blades are better. Fewer blades generally mean higher rpm, which is what you want for generating electricity. More blades generally mean more torque, which is what you want for doing mechanical work, like pumping water. Most modern wind-electric generators have three blades—a good compromise between speed and rotor balance. Water-pumping windmills use a large number of blades to do their low-speed work.

Judging and comparing the size of different wind generators is not particularly intuitive. Even from a distance, it’s pretty easy to make a good guess about a person’s height. Basketball player Wilt Chamberlain was never confused with jockey Willie Shoemaker. But judging the swept area of a wind generator based on its blade length isn’t as easy, and comparing different rotors is even more difficult. For

example, just adding 1 foot to a 10-foot blade will increase the swept area by 20 percent.

The formula for the area of a circle is π (roughly 3.14) multiplied by the radius squared. So a 6-foot-diameter rotor sweeps about 28 square feet ($3 \times 3 \times 3.14$). Double the diameter to 12 feet and the swept area quadruples to about 113 square feet ($6 \times 6 \times 3.14$). Double it again and the swept area will quadruple again.

Why is this important? A small collector will gather a small amount of energy; a larger collector will gather more. Just as two, 100-watt PV modules will generate twice as much electricity as one, doubling your swept area will roughly double the energy into your batteries or onto the grid, all other things being equal.

Understanding how to choose the right size wind generator for a given application is difficult. Wind nerds argue ad nauseam about average wind speed, wind distribution, efficiency, capacity factor, and other techie details. Looking at the collector size cuts through much of this technical fog.

As wind-energy journalist Paul Gipe says, “Nothing outside the wind itself...is more important in determining a wind machine’s capability of capturing the energy in the wind than the area swept by the rotor.” So if you’re confused about what to expect from a wind generator, look *first* at the rotor size. Don’t expect a small rotor to deliver a lot of energy. It takes a big collector to capture big energy.

See Mick Sagrillo’s wind-generator comparison article for the square footage of most home-scale North American wind generators, and Hugh Piggott’s article on estimating energy from the rotor size. Next column, I’ll talk about how a wind generator furls.

Access

Ian Woofenden, PO Box 1001, Anacortes, WA 98221 •
ian.woofenden@homepower.com

“Apples & Oranges 2002: Choosing a Home-Sized Wind Generator,” by Mick Sagrillo in *HP90*, and on the *HP* Web site

“Estimating Wind Energy,” by Hugh Piggott in *HP102*



User Friendly Hydro Power

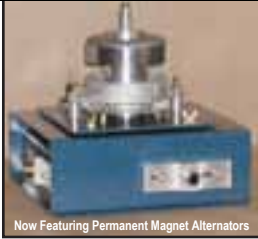

Now Featuring Permanent Magnet Alternators

Alternative Power & Machine

4040 Highland Ave. Unit #H • Grants Pass, OR 97526 • 541-476-8916
altpower@grantspass.com

www.apmhydro.com

FORCEFIELD

www.wondermagnet.com

www.otherpower.com

NdFeB Magnets
Magnet Wire
Books
Weird Science

877-944-6247 (toll free)
970-484-7257
2606 W. Vine Dr.
Fort Collins, CO 80521
ff@wondermagnet.com



Needful Things
for the homebrew
renewable energy
enthusiast!

**MAKE YOUR
ELECTRICITY
FROM SCRATCH!**

Increasing energy costs driving you crazy?

Take control with Sunda vacuum tube technology for year round solar water heating - Domestic Hot Water, Home Heating, Pools & Spas, Agricultural and Industrial Applications

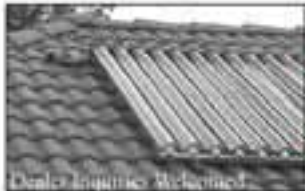

Features

- Higher efficiencies in cold and overcast conditions
- Easy installation & servicing
- Attractive pricing



Sun Spot Solar & Heating, Inc.

Website: www.sssolar.com / Email: info@sssolar.com

Tel: (570) 422-1292

U.S. Sales Agent for Sunda Evacuated Tube Collectors



Solar Meter

The easiest way to obtain accurate irradiance readings.

Pocket-sized • Rugged
Dependable • Consistent

Daystar

3240 Majestic Ridge,
Las Cruces, NM 88011

505-522-4943

pvvern@zianet.com

www.raydec.com/daystar

Log-on to your future @ www.solarenergy.org

Renewable Energy Online Education

Photovoltaic Design Online Course

Mar 14 – Apr 22 • May 31 – Jul 8 • Sep 6 – Oct 14

Solar Home Design Online Course

Sep 6 – Oct 14

"The course was exactly what I had hoped for. It covered all of the key areas and built on them in each successive chapter. Well planned and increasing challenging. Well worth the cost and I am looking forward to applying the knowledge to my own design. The contacts and links were exceptional and will be used over and over again."

-- Spring 2003 Course Participant

Online alums get tuition discounts to future hands-on workshops!

Start your renewable energy education from home...TODAY!

Solar Energy International

www.solarenergy.org • sei@solarenergy.org • 970-963-8855



You Can Get Here from There

Kathleen Jarschke-Schultze

©2005 Kathleen Jarschke-Schultze

I was outside when a woman called our business. Just as I took the cordless phone from my belt and answered, one of my roosters crowed. "I hear chickens," she said. "You caught me in the vineyard, up the hill from the chicken coop," I replied. "Ooh," she breathed, "You are living the life we all dream about." Our lifestyle is possible because Bob-O and I have our land.

A Place in the Sun

That started me thinking. How do people find their renewably powered dream homes, their places in the sun? I have heard a lot of stories from many people. While all are interesting, some are downright fascinating.

Bob-O and Kathleen use a GPS to locate a corner marker for their "barony."



I have to warn you that I am not going to actually name the places I am writing about. After all, people chose these places because they wished to be off the beaten path—you might even say obscure. If you want to find a little piece of earth (and sun, with possibly water and wind) of your own, it is up to you to choose a methodology for finding your place, or allow chance to open a door of opportunity for you.

I've already related in detail how Bob-O and I came to find our very rural land. It began with a tree falling on Bob-O and breaking his leg, in two places. It ended with us buying our house and both acquiring jobs in the bargain (HP96 and HP97). We call it our land barony.

Instead of relying on fate, many people actually go looking for a place to live their remote renewable energy (RE) lifestyle. There are several unusual ways to go about it, some of which are discussed below. The most common way is through a real estate agent.

A Realtor Runs Through It

Up here on the creek, we call the spring thaw "Realtor weather." This is when local real estate agents load up prospective clients into SUVs and drive them out to whatever acreage is for sale at the time. They have to use SUVs because all the roads still require four-wheel drive.

Spring is beautiful here. The hills are green. All the creeks are running hard. The effects of brush fires from the last year have been softened by new growth. New wildflowers are blooming every day. This has enticed many an unwary dreamer into buying what they think is a charming location.

Not many newcomers are prepared for the summer's brutal heat, the rattlesnakes, dry creeks, vicious star thistle, and unimproved roads. Then there's the fact that our whole county is open range. If you don't want cows in your yard, you have the right to fence them out. If they break down your fence, you have every right to repair it—all at your own cost, of course.

Then comes the winter. The roads quickly deteriorate into slimy mud trails. Water lines freeze. The mountain pass to town can close at any time. I've known a wintertime trip into town to take two days, though it only takes about one hour in good weather. In fact, when you give directions

around here, you always state how long it will take to get to a place, instead of the mileage, as in: "Happy Camp is two hours downriver, with dry pavement." Without dry pavement, all bets are off.

In spite of the apparent adversity of life beyond "Realtor weather," a few hardy souls actually end up loving everything about this place. These folks are our neighbors.

In the Dark

I was at the SolWest Renewable Energy Fair last July. One evening, as a group of us ate in a local restaurant, the woman next to me told me how her parents had found their dream locale. This is such a great story, I can't resist including it here.

Her father was a commercial airline pilot. For the last ten years of his flying career, he noted the darkest places in the United States that he flew over. Then on his vacation time, he and his wife would go check them out. They picked a beautiful little valley that I am familiar with. The mother is a concert musician and feared she would have to give up playing with a group. But no, she found a local group of musical peers, and is quite happy.

Tortilla Stop

I wrote to a friend who lives by that same town, and I told her this story. She had an even better story about a neighbor of theirs who had a peculiar method of determining his perfect place to live. She swears this is true. He put a tortilla on his car antenna and drove until someone asked him what it was. There he settled.

Dog Days

My brother, Mike, lived in a small town in the mountains of Colorado. One of his buddies left his home in the eastern United States and started driving. He wasn't really sure what he was looking for. When he drove into this small mountain community for the first time, he decided that it was the place for him. There on Main Street, the local town dogs were sleeping in the potholes. Obviously, this was a town with a slow pace of life.

Horse Cents

We have friends who are horse crazy. Once, when one of their horses was lame, they went to a commercial stable to ride. After spending an afternoon riding in the hills around the stable, they came across what appeared to be an abandoned ranch, aged and in disrepair. That evening, while having a beer with the stable hands, they found out it was for sale. Now they ride their horses on the same trails, but they own them. They put an RE system in first and will use that to build their new house. For want of a horse, their land was found.

Lost & Found

Are there coincidences? Or is there such a thing as joss or kismet? Serendipity? People have told me that while looking for a piece of land, they got lost. While "lost," they happened across the land they ended up buying. I am a

great believer in events happening for a reason. Of course, we are not always privy to that reason.

Born to It

Some people are lucky enough to be born in the area they want to live. Bob-O's son, Allen, is indeed one of those people. He was born in the back of a Rambler station wagon, on a mountain pass, in a blizzard. I don't know your definition of a blizzard, but around here it is when the snow blows sideways, hard and cold.

Allen was lucky enough to have the very same doctor who delivered his mother there to deliver him. The doctor knelt on the open tailgate. Allen's grandmother stood behind him, bracing his feet on her thighs. She held her jacket open as wide as she could to keep the snow from blowing into the car. A snowplow drove up and pulled over. The driver rolled down his window and called to Grandma Nancy, "What's going on? You guys need any help?"

"No," Grandma Nancy shouted back over the storm, "We're just having a baby!" The doctor quipped later that he felt he should have put the elevation on the birth certificate. It was 2,859 feet. Allen's roots remain intertwined with the big Douglas firs in the Salmon River Mountains.

Is there a right way or a wrong way to look for your place in the sun? Absolutely not! Although all roads do not lead to your special place, one does. Just watch out for the ruts.

Access

Kathleen Jarschke-Schultze is planting this year's garden at her land barony in northernmost California. c/o *Home Power* magazine, PO Box 520, Ashland, OR 97520 • kathleen.jarschke-schultze@homepower.com





Healthy Living Paints

Zero VOC Interior Paints, Clay-based Wall Coverings, Color Washes, Pigments and Milk Paints.
NEW! Aqua Resin Stain Finish Water-based, Zero VOC Interior/Exterior Wood Stains.



For a **FREE** Color Catalog call us at (800) 621-2591
www.bioshieldpaint.com



SAN JUAN COLLEGE
FARMINGTON, NM

Earn a degree in Renewable Energy
with a concentration in Photovoltaic Design and Installation

- ◆ Two-year AAS degree or one-year certificate. Both emphasize full NEC compliance.
- ◆ Combine science with hands-on learning.
- ◆ Tuition \$420/semester out-of-state and \$300 in-state.

Tom Munson, (505) 566-3003 or (800) 241-6327
munsont@sanjuancollege.edu
www.sanjuancollege.edu/reng

Al Rutan—The Methane Man

The renewable energy community lost a true pioneer on January 9, 2005, and those who knew Al Rutan lost a true friend. Al passed on while staying at the home of a friend and doing what he loved—designing and fabricating a methane digester plant.

Al's dedication to our movement of renewable energy and energy self-sufficiency was technically astute, and tempered with a true concern for the animals involved in the production process. Al knew instinctively and believed deeply that we must always consider the well-being of all the creatures of Mother Earth in our quest for energy independence. His concern for the animals who walk the Earth with us is only part of Al's legacy. A former schoolteacher, Al never lost his love and desire for sharing his knowledge and experience with others who wanted to learn about methane and energy self-sufficiency. Through his Web site and his writings, Al Rutan shared the message of energy self-sufficiency with all who sought his knowledge.

Al, for your knowledge and skill, your dedication and compassion, your love of renewable energy, your willingness to share and, most of all, your friendship, we thank you. You will be missed. Rest in peace, my friend. Larry D. Barr • ldb@rebelwolf.com



Al Rutan—methane energy guru—will be missed.

It's Not That Hard

I am concerned by the possible impressions made in William Ball's article in *HP104* that might influence potential owners of renewable energy (RE) systems. Mr. Ball discusses a long and prohibitively expensive path to the implementation of an RE system for a home. I wish to advise others who may be considering a system.

I am a pretty conservative timber owner who went out years ago and bought sealed batteries, an inverter, solar-electric panels, a generator, and a wind generator, and installed them on my place in a matter of a few weeks. The nearest grid is miles away, so I have 100 percent renewable electricity. I am surrounded by strong conservationists, but am the only local landowner I know with a renewable energy system.

I did not become a lawyer, I did not become an activist, I did not go political, nor did I visit a bank. I just built the system. My advice is to do the same. Involving every incompetent agency in one's state seems to me a certain way to make the system cost ten times more than it should and take years longer to complete. Steve Dodd • sdodd@sdodd.com

Hi Steve. Thanks for writing. We also believe in "just building it," if you have the opportunity, wherewithal, and skills. There are many paths to implementing RE on a home, and yours and William's are two of them. For many folks, a path like yours is not an option—they have bureaucratic obstacles to overcome first. Bill's approach helps grease the skids for the next set of folks so they will have an easier way with the agencies. Plus, folks like you on the West Coast may have a lot easier time doing these things than the more RE-backward states out there. Regards, Michael Welch • michael.welch@homepower.com

CFL Savings

Dear *HP*, I continue to enjoy your magazine. As a result of an article published in it, I have started to purchase compact fluorescent lightbulbs (CFLs) for my new home. I am enjoying the savings from the reduced electric bill. Thank you! Sincerely, James Pollock • jpollock68@yahoo.com

PV Shortage

Allow me to broach a subject that has oddly had scant coverage in any publication in the solar industries—the PV shortage. As a solar dealer-installer going into my fourth year of business, I am aghast at what I can only describe as the imminent dismantling of the market for small PV installations by the burgeoning PV shortage. My distributors have recently had all their stock simply bought up by one or two purchasers, so there is no product for the foreseeable future for small dealers like me.

In Germany, 100 photovoltaic systems are installed every day. There are some 60,000 people employed in the solar and wind industries. If you take your browser to www.top50-solar.de, you can view the top 450 German solar Web sites, not to mention the bottom 450. This market was not built by making installers wait for months to get product. This workforce was not created by favoring only the largest system integrators and starving the small installers.

To be sure, the production incentives and cheap loans offered by the German government have been the major drivers, but the California market has enjoyed the extraordinary opportunity of instant rebates of up to 50

percent of system cost. What happened? Why are installers now waiting three to six months for product? This is not just a time lag, as many of my peers have suggested—this is a drought, this is rationing, this is the unavailability of product and the inability of a market to sustain itself, much less grow. Let's stop pussyfooting around and tell it like it is: The solar industries in the United States are poised to get yet another "black eye," and few are prepared to recognize this failure, much less take responsibility for it. Those of us who have mortgaged our assets to build the renewable energy future are being given the shaft, and I for one will not sit by silently and let it happen.

The Solar Energy Industries Association is calling for millions for solar R&D, all well and good, but who is calling for good planning? PV manufacturers are happily promoting their products, but who is creating a fair distribution of those products? Module manufacturing is growing at an exponential rate, but who forgot to make sure there would be pure silicon feedstock for those operations? The value of the U.S. dollar has been falling for months; why have PV prices not been gradually adjusted for this so as to avoid the starvation of the U.S. market?

These questions deserve serious study and serious answers, not just the simplistic cop-out of "blame Germany." In the meantime, U.S. solar installers everywhere should take this as an opportunity to build the market for solar water heating. The net amount of solar energy used in the United States has fallen for the last few years (for shame!) because so much solar thermal capacity has been taken off-line. Solar water heating is more cost effective than ever, with natural gas prices surging and spiking every year now. In Germany in 2003, solar thermal installations grew by 39 percent!

We could do the same here, but it's going to take more than just lying back and watching the rebates roll in. The solar industries in the United States need a survival strategy and it is going to have to be better than simply pulling back and waiting for profits to get fat again. We can't all cut and run for greener pastures. We are going to have to pull together and raise this market up by its own bootstraps. No one else will do it for us. Jeremy Smithson • jeremy@pugetsoundsolar.com

Exercise Bike

Dear HP, Inspired by your recent article on the homebrew exercise bicycle battery charger, I decided to build my own. I attached a 50 VDC motor to an inexpensive Sears recumbent Exercycle, using a blocking diode and an old ammeter with a shunt. I seem to be able to crank out about 4 amps at about 1 or 2 volts above battery voltage (nominal 24 V). I have to say, although you and others have hinted at this, it is a humbling experience to use this device. If I am producing the wattage that I appear to be, it would take a long time to make a dent in my battery capacity. The best I can figure, after much huffing and puffing, is that I am producing about 25 watt-hours in 15 minutes. Wow. Kind of makes one appreciate the awesome power of the sun. Thanks for listening. Geoff Yokum • bgeof@aol.com

Hi Geoff, It's true, humans cannot develop and sustain much "horsepower." Personally, I think we should wire up grid-tied generators to all the health club exercise bikes and stair-steppers—now that might make a dent. Maybe the best application of homemade bike generators is powering TVs, VCRs, and video games. That way kids would have to work harder at becoming mind-numbed couch potatoes. Michael Welch • michael.welch@homepower.com

BP Advertisement

I just purchased two copies of the most recent *Home Power* with some excitement. I bought one to give to my father to inspire him to build his own system at his home in the country, and then couldn't resist having one for myself.

But I got home and was reading through it, and then looked a little more closely at the BP ad on the back. You blew my mind—I don't understand why you would take such an advertisement. People might debate whether or not to take advertising from a giant oil company and contribute to their public relations attempts. I understand how some people think it's good to encourage these big companies to move away from fossil fuels even if they are putting more into their image than into the environment. Of course, you need advertising revenue to keep up such a good mag.

But moving away from oil is not just about the environment. Many of us recognize that wars are being fought over this stuff, atrocities are happening and have happened, perpetrated by the U.S. Army. People die when the government says "for your country," and big oil-producing companies get rich "for your country." The war against Iraq is widely talked about as having more to do with resource control than any potential threat.

Given all that is happening, and given that I would assume your readership base is more attuned to the social state of our world—why publish an ad that so clearly draws links to and supports this wrongful war?

I'm going to cut this advertisement out before giving the magazine to my father, and then I'm not sure what to do because there aren't many good alternatives to *HP* here in the Toronto bookstores I go to. I will definitely be looking for an alternative magazine in the future, and will probably not buy this magazine again. I would appreciate an explanation and position from your magazine, though. Do you have an advertisement policy? May we see it?

Maybe I'm the only one who has written to you about this, but I have had the magazine around my workplace and house only for the last few days and have already received a few questioning comments about that advertisement. I hope my letter will help represent a larger section of people out there who might not have the time to write. Brian (last name withheld)

Thanks for your letter, Brian. We have been running that ad since September 2004, and you are the fourth person who has written to us to complain. I am happy to explain our position on the ad.

In general, our advertising policy is that only products related to renewable energy may be advertised in our pages. Under this policy, you won't see ads for tobacco, cosmetics, alcohol, snake oil,

Hummers, etc. We also do not accept advertising from companies that fail to uphold high standards in fair business practices. While we don't police the industry, we pay careful attention to what our readers have to say about the performance of our advertisers. We have refused advertising in the past, and will do so in the future when appropriate.

In the present situation, we previewed the BP ad and agreed to run it on one condition—that BP provide the location of the solar-electric arrays (California) in the caption. The officer's green uniform (instead of the sand-colored ones used in the war zone) indicates that the array was not in Iraq, and we wanted that fact to be readily apparent.

The way that I and everyone on staff who previewed the ad interpreted it was, "Hey, even the U.S. government thinks that solar energy is a good idea." But that's a pretty well-kept secret. Even though they don't openly promote it, they use it in a big way for their own purposes (at locations such as the White House, the Pentagon, and in government agency installations all over the world). I definitely like being able to show the world that even though the U.S. government denounces the viability of solar energy with their words, their actions say otherwise.

The way another staffer put it was, "My read on the ad is that it says loud and clear that if we had more of those blue things (PVs), we'd need fewer of those green things (uniforms)..." Some of us particularly liked the concept of solar energy being portrayed as patriotic. We see it as a refreshing change from the misperception that all renewable energy-minded folks are anti-establishment "liberals."

Big players like BP have an important role in the industry. As you may be aware, BP has been investing in solar energy research and development for a number of years now. So have other oil companies. They have the financial means to promote the development of renewable energy (RE) technologies, which in turn brings the price down and the efficiencies, safety, reliability, and viability up for the rest of us. The industry would not be where it is today without the investments of several huge companies with deep pockets. These days, we're seeing small start-up companies making PVs because years and years of expensive R&D have already been done.

I can assure you that BP's forays into renewable energy have certainly not been the profit center that their oil business is. Do you have to trust their motives? Of course not. But can they help us reach our goals? Heck yes! One of these days, you might see the V.P. of BP Solar meeting with the U.S. Energy Secretary and the V.P. of the United States to draft policies that favor renewable energy instead of dirty energy.

Finally, we are dedicated to the public's need to understand renewable energy. Which public? All of it. Solar energy can't be reserved for just the folks who we think are cool and deserving, and are doing it for all the "right" reasons that are in alignment with our own political beliefs. We have come to the realization that it isn't for us to determine who should or shouldn't use renewables, or to judge them for what reasons bring them to using or learning about the technologies.

Basically, the more people who switch to using RE, the better off we—and the planet—will be. We'll have less pollution as a result of burning fewer fossil fuels, and fewer dangerous nuclear byproducts to deal with for the next millennium. Our mission is

to change how the world makes its energy—period. Thanks for writing in, and let me know if I can answer any further questions. Linda Pinkham • linda.pinkham@homepower.com

Solar Inspiration

Last year, my husband and I went to a volunteer appreciation day for people who helped with Miracles in Motion (horseback riding as therapy for people with handicaps). I took a copy of *Home Power* that had a feature on lighting a horse barn with solar-electric panels. The president of the group was very interested and photocopied it right then and there. The physical therapist for Miracles said it reminded her of when she accompanied her daughter's Spanish class to Peru and they visited Lake Titicaca. The natives there built reed platforms in the lake and built their houses on the platforms. The Spanish class was rowed out to meet the "island people." Here, at 14,000 feet in elevation, in the middle of the lake, were folks watching TV powered by solar-electric panels, in their reed huts built on reed islands! Bev Hannon • bahannon@netins.net

Tankless Heaters

I enjoyed your article, "Tankless Is In," in *HP105*. I would however like to point out some inaccuracies and share some information with your readers.

The "Gas Tankless Water Heater Specifications" chart inaccurately reported the Btu input of the Paloma PH28R at 119,900, when it should have been 199,900. Also, the "Typical Water Heater Characteristics" table rates gas-fired, tank-type water heaters at an energy factor of 0.65. Very few gas-fired, tank-type water heaters reach 0.65 energy factor (see www.gamanet.org).

Finally, your list of tankless gas water heater manufacturers is really a list of marketing companies involved in reselling tankless water heaters. AquaStar is made by Bosch (Portugal), Powerstream is made by Redring (UK), Bradford White is made by Rinnai (Japan), Infinion is made by Saunier Duval (France) and Vaillant (Germany), Rheem is made by Paloma (Japan), Noritz (Japan) will be manufacturing for A.O. Smith and State, and Takagi is made in Japan. All this brings me to WaiWela (pronounced ViVela—"hot water" in Hawaiian), which is made by Paloma and is the only tankless gas water heater that is advertising in your magazine.

The most important thing that is missing from your article is the issue of safety. Gas appliances can be dangerous either to humans or to the environment. The main issue is combustion emissions. Because most of the tankless gas water heaters available in the United States are fan-assisted gas appliances that have their flue emissions under a positive pressure, special venting material is required for safe and proper installation. Without the use of Category 3 venting material or given a blocked flue, there is a risk of flue gases, such carbon monoxide, carbon dioxide, and nitrous oxides, entering the living space.

WaiWela/Paloma addresses the need for emissions protection by engineering a special gas burner that includes a sampling zone where emissions are constantly sampled.



The WaiWela/Paloma water heater features emergency shutoff.

We call this feature the oxygen depletion sensing system. It samples emissions and makes corrections in fan speed to improve combustion. If sampled emissions of carbon monoxide exceed 200 ppm, and the emissions cannot be reduced with fan-speed adjustments, the heater shuts down and displays an error code. Neil Greenzweig, WaiWela Tankless Gas Water Heaters • www.waiwela.com

And More on Tankless Heaters

Thank you for a pretty good article on tankless water heaters. Some important omissions were made, and some less important errors are in it. It would be very helpful to distinguish between atmospheric draft, forced draft, and sealed combustion gas water heaters, since putting an atmospheric draft combustion appliance in a tight house or wrong location in a house can cause life-threatening back drafting and carbon monoxide exposure. Forced draft (fan-forced) appliances are safer, but still need combustion air taken from indoors, which may mean big holes in an outside wall, and definitely an increased house infiltration rate. Sealed combustion is safest, and most efficient. I only install sealed combustion appliances indoors. Rinnai and Takagi both offer sealed combustion models.

The energy rating of electric tank-type water heaters eligible for our local utility rebate is 0.93. You can improve on that by putting them in a heated space and building a foam box around them—a treatment your solar tanks should also receive. The very marginal efficiency advantage of tankless electric units over tank-type electric, along with the outrageously high electric demand, should relegate tankless electric equipment to very special circumstances. Spend that money on a solar water heater! If your electric utility has time-of-use rates, your tank-type water heater can coast through the high cost periods if you put a time clock on it. Some heat pump water heaters attach to standard electric tanks, for the most efficient water heating with nonrenewable fuels.

Most tankless models allow the exiting water temperature to drop as their maximum heat rise per gallons per minute is exceeded. The Rinnais reduce flow rate to maintain exiting water temperature in this situation. The high-Btu burner size on most tankless water heaters means that you actually have to do a simple calculation to make sure the gas supply lines are not undersized. A very general rule is to use 1 inch or larger. The gas company and installer may have to be reminded repeatedly and in writing of this amazing fact!

Little known fact: the Rinnais will get squirrely if water pressure drops below 40 psi. Some of the other high-tech gas tankless units may have similar limitations. The Rinnai 2532 at least is solar compatible, having a fully modulating burner and electronic controls. You may need to feed some tankless units solar preheated water that is run through a tempering valve so that the water heater has something to do. If the water is that hot, turn off the gas and go solar direct.

The Rinnais come as indoor or outdoor models. The indoor model is sealed combustion, slightly more efficient, and is less likely to freeze solid if you have a power failure and a cold spell simultaneously.

Safe and effective tankless water heater de-scaling should involve a circulating pump that keeps the cruddy stuff moving through. Vinegar and a 5-gallon bucket complete the picture.

A cold-water sandwich is what I call it when your showerhead delivers alternately scalding hot and then cold water. Some of the less sophisticated tankless gas units will do this unpleasant dance for you, and this may be why some plumbers nurture an irrational hatred for tankless water heaters. Installing a passive 5- to 10-gallon buffer tank will help the sandwich problem, but leads to a long wait for hot water. Alan Van Zuuk, Eugene, Oregon • arvz@cyber-dyne.com

LEDs

Greetings, I noticed in *HP104* that Thailand has hardly any incandescent bulbs for sale in their shops. I'm going to be so glad when that happens here in Canada. I've been telling folks about compact fluorescent lightbulbs and LEDs for a couple of years, but people don't seem keen on changing to them. I only have a few of those wasteful incandescent lights left, and they are in parts of the basement where I rarely go. I still use them in the fridge and freezer, but that will change when I can find LED replacements.

I'm also hoping to replace all of my flashlight bulbs with LEDs. There's one in my wall-mounted flashlight, and it makes the battery last ten times longer, plus it keeps on giving off light when the battery voltage is low. Incandescent bulbs become almost useless at half their voltage. Mr. Edison's invention served us for more than a hundred years, but it's time to switch to an efficient light source. Yours, Bruce Atchison • ve6xtc@telusplanet.net

Thermal Performance Software

Thanks for your excellent article on avoiding passive solar design blunders. I would like to add another resource for your readers. When I was designing a passive-solar-assisted addition to my home, I came across the free software

Solar-5 (www2.aud.ucla.edu/energy-design-tools) for simulating the thermal performance of a home on an hourly basis using local climate information.

I had originally hoped to design a completely solar-heated room for my Massachusetts home, but by using this software, I came to realize that wouldn't be possible for me. But with the trade-offs I was willing to make, I could expect to pay just US\$50 per year for heat. I was able to try different window sizes and orientations, and various insulation levels in simulation to see their effects. The program output shows hourly fuel use and room temperature in easy-to-read graphs.

Now that the addition has been complete for several years, I'm happy to say that we didn't encounter any surprises not forecast by the software, and that the simulations were pretty accurate. Regards, Carl Windnagle, Hudson, Massachusetts • slr.20.windnagle@xoxy.net

Sizing a Desert System

Hi, I will be moving to the Tucson, Arizona, area soon. I am having a home built there and I will have a solar-electric system. I am kind of an electronics geek, so I am looking forward to this, but I am new to it.

I now use 68 KWH per day in Chicago. The new house will have a pool and hot tub, so I think it will use 75 to 100 KWH per day. Can you help me figure out what I will need for this off-grid system—I know that is a lot of energy, and I don't even know if it can be done. If not, what is the biggest system I could build? Thank you. Dennis Brown • dennis@air-wans.com

Hi Dennis. The sky is the limit for system size. Well, usually the wallet is the limit. Here are some thoughts on your new home.

- *Build it with passive solar design—Tucson is a great place for solar technology.*
- *Include solar pool and hot tub heating. This will pay for itself quickly with decreased energy bills.*
- *Small is better, when considering our footprint on Earth.*
- *Figure out other ways of saving energy. For every dollar spent on efficiency and conservation, you will save three to five dollars on the cost of a solar-electric system designed to run the home.*
- *Contact a reputable solar dealer—installer. You should have your system installed professionally—doing the job right and within code takes a lot of experience and knowledge.*

Hope that helps. Michael Welch • michael.welch@homepower.com

Gaining Solar Access

In my city, and in most cities in the United States, giant trees tower over our homes and businesses. Trees are my favorite creatures, but when the really big ones are planted too close to buildings, they block the sun's rays that are needed for solar panels, which are usually mounted on roofs. In Minnesota and several states across the country, generous rebates, grants, and low-interest loans are available (see www.dsireusa.org) for those who install solar panels. Most people mount the panels on the roofs of their homes or businesses. The Minnesota grant program requires good solar access, and other states may do the same.

So I've been on a campaign to not only plant shorter trees next to most homes and buildings, but to plant fruit trees, so our yards and boulevards can be not only beautiful, but so we can have edible landscapes. Instead of shipping pesticide-laden fruit from South America in refrigerated planes and trucks, we can get much of our produce in our own yards. Don Johnson, Minneapolis, Minnesota • aaarty@aol.com

Hi Don. Right on. Another factor is that many states and municipalities have solar access laws, which give you the right to sun on your home. They forbid neighbors from doing things that will shade the homes around them. Some solar access laws allow the grandfathering in of trees and other things that were there before the laws were passed. I love your idea of edible landscapes in the city. Michael Welch • michael.welch@homepower.com

The Home Energy Diet
How to Save Money by Making Your House Energy-Smart
Paul Schedel

A practical guide to becoming energy literate, enabling readers to take control of their home energy use to save money, live more comfortably and help the environment. \$18.95
A Mother Earth News Wiser Living Series book

Real Goods Solar Living Source Book
The Complete Guide to Renewable Energy Technologies & Sustainable Living
John Schaeffer, ed.

In its 12th Edition this is the ultimate resource on renewable energy, sustainable living, alternative construction, green building, homesteading, off-the-grid living and alternative transportation, and this new edition contains much new material. \$35.00

Green Building Products
The GreenSpec Guide to Residential Building Materials
Mark Piepkorn, ed.

Provides descriptions and manufacturer contact information for more than 1,400 environmentally preferable products and materials for all phases of residential construction. \$34.95

NEW SOCIETY PUBLISHERS
800.587.8772 www.newspublishers.com

share what you know!

Write for Home Power

We're always looking for fresh and inspiring new articles to publish. If you've got a renewable energy story to tell or an area of relevant expertise or experience, consider sharing what you know with other *Home Power* readers.

Have an idea? We're all ears.

Before you start writing, drop us an e-mail at submissions@homepower.com describing what you have in mind. Floating your idea up front could save you a lot of time. If it sounds like a good fit for *Home Power*, we'll work with you to define the editorial, photographic, and informational components needed to cover the topic.

Not a Writer? Not a problem.

We have a top-notch editorial staff who love nothing more than to make you sound brilliant. Don't be shy.

For more information, see our complete submissions guidelines on our Web site.

www.homepower.com/writing



Do You Need Batteries?...

RAE Storage Battery Company

Since 1943... Quality & Service

Surrette Solar 1, 400 Series, Type CH 375 - L16

Engineered under careful guidelines by Dave Surrette - Family owned business Est. 1935

Gambissara Solar for export

212-206-6344 • 1201 Broadway, Room 809, New York, NY 10001

Newly established factory warehouse. U.S. Battery Co. Corona, CA



Phone 860-828-6007
Fax 860-828-4540
51 Deming Rd., POB 8005,
Berlin, CT 06037

MALLARD WIND GENERATORS

Economical, Strong, & Very Reliable

MALLARD
800E

SALE

800 Watt
\$389
Regular price
\$475

Package
Deal 3-800E
& Regulator
\$1099

We also have charge regulators, tower kits & plans, PMAs, blades, and lots of friendly advice & customer support.

Mike's Windmill Shop

www.mikeswindmillshop.com • 928-532-1607
Major Credit Cards Accepted • Call for Volume Pricing

BATTERY BOX VENTILATOR & BACK DRAFT DAMPER

- Positive hydrogen venting
- Stops back drafts
- Minimal power consumption

* Available from dealers and distributors across the U.S. and Canada



POWER VENT
12v & 24v - \$79
48v - \$104
+ \$10 S&H (cont. U.S.)

THE
POWER
VENT

Zephyr Industries, Inc.
POB 52, Salida, CO 81201
719.530.0718
www.zephyrvent.com

INTERNATIONAL

Solar On-Line (SóL); Internet courses on PV, green building & international development. Info: SóL, PO Box 217, Carbondale, CO 81623 • 720-489-3798 • info@solenergy.org • www.solenergy.org

Solar Energy International online; Internet courses on PV Design & Solar Home Design. Info: see SEI in Colorado listings.

BELIZE

Dec. 5–9, '05; Understanding PV. Lectures & labs. Learn design & installation principles of PV systems: stand-alone, grid-tie, water pumping & more. Info: Ecovillage Training Center • 970-527-4680 • ecovillage@thefarm.org • www.thefarm.org

CANADA

Alberta Sustainable Home/Office; Calgary. Open last Sat. every month 1–4 PM, private tours available. Cold-climate, conservation, RE, efficiency, etc. Info: 9211 Scurfield Dr. NW, Calgary, AB T3L 1V9 • 403-239-1882 • jdo@ecobuildings.net • www.ecobuildings.net

CZECH REPUBLIC

Sep. 7–9, '05; Green Power Central & Eastern Europe, Prague. Utility-scale RE finance & regulatory frameworks. Info: See "Green Power Conferences" under Rome, Italy

FRANCE

Apr. 4–8, '05 (again May 16–20); Solar Electricity Installation Course, Saint Laurent de Cerdans. Learn how to design & install a solar-electric system, course in English. Info: Green Dragon Energy • 44 1654-761-731 • courses@greendragonenergy.co.uk • www.greendragonenergy.co.uk

GERMANY

Jun. 21–22, '05; European Solar Thermal Industry Conference, Friburg. Solar thermal energy markets, promotional policies, marketing, technology & certification. Info: European Solar Thermal Industry Assoc., RE House, 26, Rue du Trone, B-1000 Bruxelles • 32-2-546-19-38 • Fax: 32-2-546-19-44 • info@estif.org • www.estif.org-solar.de

HONG KONG

Jun. 15–16, '05; Renewable Energy Finance Asia. Learning & networking. Info: See "Green Power Conferences" under Rome, Italy

ITALY

May 5, '05; SolarExpo, Vicenza. Int'l. Conf. & Exhibition on RE, distributed generation & green building. Info: Chiara Borsato • 39-0439-849-855 • press@solarexpo.com • www.solarexpo.com

Nov. 14–16, '05; Green Power Mediterranean, Rome. Policy & networking. Info: Green Power Conferences, 145-147 Saint John St. 2nd Fl., London EC1V, UK • info@greenpowerconferences.com • www.greenpowerconferences.com

NICARAGUA

Jul. 31–Aug. 11, '05 (again Jan. 2–13, '06); Solar Cultural Course; Managua. Lectures, field experience & ecotourism. Info: Richard Komp • 207-497-2204 • sunwatt@juno.com • www.grupofenix.org

PERU

May 30–Jun. 10, '05; RE in Developing Countries; Cajamarca, Peru. Intensive training on microhydro & solar power. Info: Green Empowerment, 140 SW Yamhill St., Portland, OR 97204 • 503-284-5774 • pam@greenempowerment.org • www.greenempowerment.org

SOUTH AFRICA

Apr. 18–22, '05; RE World Africa 2005, Midrand, Johannesburg. Conference, exhibition & energy fair. Info: Christopher Raubenheimer • 27-11-463-2802 • chris.raubenheimer@terrapinn.co.za • www.powergenerationworld.com/2005/renew_za

UNITED KINGDOM

Apr. 18–21, '05; Int. Power Sources Symposium & Exhibition, Brighton Corn Exchange. Storage of RE. Info: www.ipss.org.uk

May 5–7, '05; Clean Energy Technology & Investment Exhibition, London. Info: LPB Events, 18 King Edward Buildings, 629 Fulham Rd., London SW6 5UH • 0207-751-9998 • www.clean-energy-expo.com

U.S.A.

American Wind Energy Assoc.; Info about U.S. wind industry, membership, small turbine use & more. www.awea.org

Info on state & federal incentives for RE. North Carolina Solar Center, Box 7401 NCSU, Raleigh, NC 27695 • 919-515-5666 • www.dsireusa.org

Ask an Energy Expert; online or phone questions to specialists. Energy Efficiency & RE Network (EREN) • 800-363-3732 • www.eere.energy.gov

Stand-Alone PV Systems Web site; Design practices, PV safety, technical briefs, battery & inverter testing. Sandia Labs • www.sandia.gov/pv

ARIZONA

Apr. 23, '05; Tucson Solar Potluck; Catalina State Park. Solar potluck. Bring solar oven &/or bring a dish. Music, food, PV demo, solar fountains & kids' activities. Info: 520-885-7925

Scottsdale, AZ. Living with the Sun; free energy lectures, 3rd Thurs. each month, 7 PM, City of Scottsdale Urban Design Studio. Info: Dan Aiello • 602-952-8192; or AZ Solar Center • www.azsolarcenter.org

CALIFORNIA

Apr. 8–10, '05; Alternative Fuel Summit, Firebaugh, CA. Biodiesel, SVO, ethanol & electric propulsion. Workshops: engine conversion & fuel processing. Info: Mercey Hot Springs, 62964 Little Panoche Rd., Firebaugh, CA 93622 • 209-826-3388 • www.merceyhotsprings.com

Apr. 23, '05; Sustainable Living & Arts & Music Festival; Humboldt State Univ., Arcata, CA. RE workshops and exhibits, RE-powered music. Info: Associated Students, HSU, Arcata, CA 95521 • 707-826-4221 • hsuas@humboldt.edu

Arcata, CA. Campus Center for Appropriate Technology, Humboldt State Univ. Workshops & presentations on renewable & sustainable living. CCAT, HSU, Arcata, CA 95521 • 707-826-3551 • ccat@humboldt.edu • www.humboldt.edu/~ccat

Hopland, CA. Ongoing workshops, including beginning to advanced PV, wind, hydro, alternative fuels, green building techniques & more. Info: Solar Living Institute, 13771 S. Hwy. 101, Hopland, CA 95449 • 707-744-2017 • slis@solarliving.org • www.solarliving.org

COLORADO

Denver. Windhaven RE seminars; Solar Energy Basics, Biodiesel & Alt. Fuels, Wind Energy Basics, Alternative Building, others. Info: Windhaven Foundation for Sustainable Living, 6795 S. Field Ct., Littleton, CO 80128 • 720-404-9971 • windhavenco@yahoo.com • www.windhavenco.org

Carbondale, CO. SEI hands-on workshops & online distance courses on PV, solar pumping, wind power, RE businesses, microhydro, solar thermal, alternative fuels, green building & women's courses. Info: Solar Energy International, PO Box 715, Carbondale, CO 81623 • 970-963-8855 • sei@solarenergy.org • www.solarenergy.org

FLORIDA

Aug. 6–12, '05; Solar World Congress, Orlando. Symposium, workshops & exhibition for International Solar Energy Society & American Solar Energy Society. Info: www.swc2005.org

ILLINOIS

Chicago. Urban Enviro Living Workshops. 2nd & 4th Thurs. each month, 7 PM. Sustainability, energy efficiency & conservation, RE & green building. Info: 312-842-8727 • hometown.aol.com/ecadvocate

IOWA

Prairiewoods & Cedar Rapids, IA. Iowa RE Assoc. meets 2nd Sat. every month at 9 AM. Call for changes. Info: IRENEW, PO Box 3405, Iowa City, IA 52244 • 563-432-6551 • irenew@irenew.org • www.irenew.org

MICHIGAN

Apr. 16, '05; Introductory RE seminar; Dimondale, MI. Answers common questions about RE applications. Info: Great Lakes Renewable Energy Association • 800-434-9788 • info@glrea.org • www.glrea.org

West Branch, MI. Intro to Solar, Wind & Hydro; 1st Fri. each month. System design & layout for homes or cabins. Info: 989-685-3527 • gotter@m33access.com

MINNESOTA

Apr. 30–May 1, '05; Living Green Expo, St. Paul. Sustainable living fair, workshops, exhibits & info on RE, transportation & green building. Info: 612-331-1099 or 651-215-0218 • www.livinggreenexpo.org

NEW MEXICO

May 20–22, '05; Conf. of the Adobe Assoc. of the Southwest; El Rito, NM. Info: Northern New Mexico Community College • Quentin Wilson • 877-806-2987 or 505-581-4156 • info@adobeasw.com • www.adobeasw.com

Feb.–Mar. & again Oct.–Nov. each year. Intro to Homemade Electricity; Deming, NM. 5 Thurs. eves. Info: Mimbres Valley Learning Center • 505-546-6556 ext. 103

NEW YORK

Oct. 27–28, '05; Green Power North America, NY City. Info: Green Power Conferences, 145-147 Saint John St. 2nd FL, London EC1V, UK • info@greenpowerconferences.com • www.greenpowerconferences.com

NORTH CAROLINA

Apr. 15–16, '05; Wind Resource Assessment. Beech Mountain, NC. Hands-on, qualitative & quantitative methods for wind resource assessment, including anemometer installation, data collection, analysis & equipment maintenance. Info: North Carolina Small Wind Initiative • 828-262-7333 • wind@appstate.edu • www.wind.appstate.edu

May 21–22, '05; Small Scale Wind Energy, Beech Mountain, NC. Hands-on AWP turbine workshop. Info: see North Carolina Small Wind Initiative above.

Jun. 25–26, '05; Small Scale Wind Energy, Beech Mountain, NC. Hands-on Bergey, with installation, wiring & troubleshooting. Info: see North Carolina Small Wind Initiative above.

Sep. 17–18, '05; Grid-tie Wind Installation Workshop, Beech Mountain, NC. SWWP installation. Info: see North Carolina Small Wind Initiative above.

Pittsboro, NC. RE, biofuels, green building & other sustainable living courses at Carolina Community College. Info: Piedmont Biofuels Coop • 919-542-6495 ext. 223 • www.cccc.edu or www.biofuels.coop

Saxapahaw, NC. How to Get Your Solar-Powered Home. Info: Solar Village Institute, PO Box 14, Saxapahaw, NC 27340 • 336-376-9530 • info@solarvillage.com • www.solarvillage.com

OREGON

Jun. 27–Jul. 1, '05; SEI's Carpentry Skills for Women, Portland. Intro to carpentry for women. Info: see SEI in Colorado listings.

Cottage Grove, OR. Adv. Studies in Appropriate Tech.; 10 weeks, 14 interns per quarter. Info: Aprovecho Research Center, 80574 Haxelton Rd., Cottage Grove, OR 97424 • 541-942-8198 • apro@efn.org • www.aprovecho.net

PENNSYLVANIA

Oct. 14–15, '05; Passive Solar Greenhouse Workshop; Spring Grove, PA. Design, construction & year-round production. Info: Steve & Carol Moore, 1522 Lefever Ln., Spring Grove, PA 17362 • 717-225-2489 • sandcmoore@juno.com

Philadelphia, PA. Penn. Solar Energy Assoc. meetings. Info: PO Box 42400, Philadelphia, PA 19101 • 610-667-0412 • rose-bryant@erols.com

SOUTH DAKOTA

Aug. 8–18, '05; Sustainable Training workshop for Native Americans; Pine Ridge Reservation, SD. Concepts, installation & maintenance of PV, microhydro, small wind, straw bale, ecological design & wastewater treatment. Info: PennElys GoodShield, Sustainable Nations Development Project • PO Box 1111, Trinidad, CA 95570 • 707-677-3588 • sustanablenations@hotmail.com

TENNESSEE

May 4–7, '05; Understanding PV, The Farm. Lectures & labs. Learn design & installation principles of PV systems: stand-alone, grid-tie, water pumping & more. Info: Ecovillage Training Center, 970-527-4680 • ecovillage@thefarm.org • www.thefarm.org

TEXAS

Apr. 4–9, '05; PV Design & Install workshop, Austin. System design, components, site analysis, system sizing & hands-on installation. Info: see SEI in Colorado listings.

May 23–27, '05; New Ecological Home workshop, Austin. Ecological design, green building, energy efficiency, passive solar, sustainable community design & more. Info: Omega Institute • 877-944-3003 • www.omegacrossings.com

El Paso. El Paso Solar Energy Assoc.; meets 1st Thurs. each month. Info: EPSEA, PO Box 26384, El Paso, TX 79926 • 915-772-7657 • epsea@txses.org • www.epsea.org

Houston. Houston RE Group meetings. Info: HREG • hreg04@txses.org • www.txses.org/hreg

UTAH

Apr. 4–9, '05; PV Design & Install workshop, Salt Lake City. System design, components, site analysis, system sizing & hands-on installation. Info: see SEI in Colorado listings.

WASHINGTON STATE

Oct. 8, '05; Intro to RE; Guemes Island, WA. Solar, wind & microhydro for homeowners. Info: see SEI in Colorado listings • Local coordinator: Ian Woofenden • 360-293-7448 • ian.woofenden@homepower.com

Oct. 10–15, '05; PV Design & Install workshop; Guemes Island, WA. System design, components, site analysis, system sizing & a hands-on installation. Info: see above.

Oct. 17–21, '05; Microhydro Power workshop; Guemes Island, WA. Design, system sizing, site analysis, safety issues, hardware specs & a hands-on installation. Info: see above.

Oct. 24–29, '05; Wind Power workshop; Guemes Island, WA. Design, system sizing, site analysis, safety issues, hardware specs & a hands-on installation. Info: see above.

WISCONSIN

MREA '05 workshops; Basic, Int. & Adv. RE; PV Site Auditor Certification Test; Veg. Oil & Biodiesel; Solar Water & Space Heating; Masonry Heaters; Wind Site Assessor Training & more. Info: MREA, 7558 Deer Rd., Custer, WI 54423 • 715-592-6595 • info@the-mrea.org • www.the-mrea.org



Send your renewable energy event info to happs@homepower.com

Matrix
Solar Technologies

FREE solar energy for the next 10 billion years...

Don't let this deal pass you by.

540-A Silver Creek Rd. NW Albuquerque, NM 87121
Phone: (505) 833-0100 Fax: (505) 833-0400
www.matrixsolar.com

©Matrix Solar Technologies is a subsidiary of ATS Automation Tooling Systems

Digital Back Issues
Instant (paperless) satisfaction!

Every back issue of *Home Power* is available in PDF at www.homepower.com

Search or browse our subject index, then purchase & download what you need!

Haven't been to homepower.com in a while? Check it out!

- Our online store is always open for business! Subscribe or renew, shop specials, CD-ROMs, back issues, and gifts, or review your order history!
- In need of technical advice & RE information? Search our directory of RE businesses, browse upcoming events, articles, stocks, job openings, or e-mail us your tech questions!

2005

REAL GOODS

solar
living
INSTITUTE



green living workshops



promoting
sustainable living
through
inspirational
environmental
education

2005

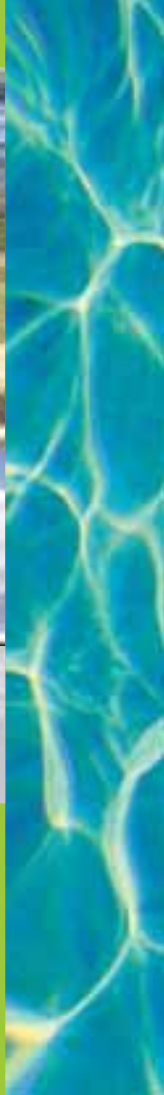

hands-on classes
come to our world famous,
12-acre, solar-powered
demonstration site in hopland,
CA to learn from expert
instructors in the world's
premier renewable energy
training program

RENEWABLE ENERGY:
on-grid and off-grid solar,
hands-on installations, wind power,
hydropower, biodiesel and more

GREEN BUILDING:
straw bale construction, cob,
earth ovens, natural plaster, earthen
floors, carpentry for women

PERMACULTURE:
seed saving, permaculture design
certificate, composting, graywater

OVER 25,000 GRADUATES SINCE 1993

**SOLAR INSTALLATIONS
PERMACULTURE CERTIFICATION
BUILDING WITH EARTH AND STRAW
BASIC AND ADVANCED BIODIESEL
CLASSES IN SAN FRANCISCO,
SAN JOSE AND LOS ANGELES
AND MUCH MORE!**

TELEPHONE CLASSES ALSO AVAILABLE

SU PHOTOS: DANIELLA

707-744-2017

www.solarliving.org

2005
solar
fest
Aug. 20 & 21
Hopland CA

RENEWABLE ENERGY & SUSTAINABLE LIVING FESTIVAL

questions & answers

More Batteries or a Generator?

Love your magazine! Keep up the good work. My wife and I live off grid. Our electricity sources are PVs and a Jacobs wind generator. We have twelve Rolls batteries in three strings for a 24 V nominal, 1,050 amp-hour battery bank.

We didn't calculate our energy usage vs. energy storage correctly when we designed the system. We only have about two days of storage if there is no wind or sun. I'd thought such days would be rare in New Mexico, but I forgot to factor in Murphy's Law. Twelve more batteries (doubling our storage capacity) and cabling would cost about US\$2,000. A 6 KW generator would cost not much more, about US\$2,400. Given that we only have enough money for batteries or a generator, but not both, which makes the most sense? Thanks, Grey Chisholm, Madrid, New Mexico • greychis@aol.com

Hello Grey, I'd go with the generator. We are in the same boat here as you, only we have about four days of storage. We have a 6.5 KW generator and we don't use it very much (about 150 to 200 hours per year). The generator makes it a snap to keep the batteries charged up regardless of the weather.

While additional storage would be nice, you'd still have to refill the batteries after coming out of a sunless and windless period. Also, deeply cycling the batteries will shorten their lifetime. I've designed hundreds of off-grid RE systems, and I always put a backup generator in the system. It's not used very much, but when you need it, you really need it. Richard Perez • richard.perez@homepower.com

Solar Hot Water Controller

Home Power folks, In Bob Owens' article on solar heating his hot tub (HP104), I became a little confused about the controller's duties. Because this is a drainback (no check valve) system, the collector empties every time the pump shuts down, right? This leaves the sensor for the collector reading the temperature of an empty pipe connected to other empty pipes under glass.

Now as I see it, once these pipes heat up to the set point, the pump comes on and fills these pipes with water at whatever temperature the tub is. Down goes the sensor temperature, off goes the pump, and this is repeated, over and over. Even with some hysteresis dialed in, it seems like this will happen until the temperature rises enough to lengthen the duty cycle, so the pump will run for a while.

I am sure I have put way too much thought into this and the answer is really simple, but when I model it on my computer, it works just the way I stated. Please make it simple for me again. My brain hurts! I know it must work, since it's described in the article. (Well written, and nice photos and diagrams, by the way.) Thanks, Howard Coulson • hcoulson3@aol.com

Hi Howard, I don't think you need any aspirin for the brain pain just yet, but perhaps a little better description of the GL-30 control that Bob used will help. The condition you describe is what we call "short cycling." Short cycling can occur in the

early morning or during cloudy weather in any system, even if the temperature differential is set correctly. The GL-30 has a field set-able dial that allows the user to adjust the turn-on differential from 8 to 24°F. The turn-off differential is set at 4°F, and cannot be adjusted. The differential is the measurement of the temperature difference between the two sensors. If the turn-on differential is set too low, short cycling will occur as you describe. If it is set high enough, short cycling will only occur in the early morning, late afternoon, or during cloudy weather.

Too high a setting wastes the available energy. A correctly set turn-on differential will start the pump and keep it on until the sun becomes less intense (clouds or end of the day) or the storage high limit is reached. Bob probably has his turn-on differential set between 10 and 16°F. For a drainback system without a heat exchanger, this will prevent short cycling most of the time. The exact differential operation also changes a little with local climate and the seasons of the year.

The GL-30 also has a high-limit feature that limits the storage (tub) temperature. This feature is also a field set-able dial (110 to 200°F). I would imagine Bob has this set fairly low, since a spa above about 105°F is a little too hot for comfort. If the storage sensor reaches the high-limit setting, the pump will shut off. It will stay off as long as the storage is at or above the setting, regardless of the temperature of the collector sensor. I would guess that the high limit controls Bob's system at least part of the time.

I know this concept of differential controls isn't simple by any means, but I hope a little more info on the control functions will help the headache. More detailed information on differential controls can be found in HP94 and HP103. Cheers, Chuck Marken • chuck.marken@homepower.com

AC or DC Generator?

I am designing a remote power system for my cabin. I am struggling with whether to purchase an AC or DC generator. By the vastly unscientific measure of "amount of information easily available," it seems that most people are using AC generators with a charger. On the other hand, I keep being pulled by the sales literature about the efficiency of DC generators for charging battery banks. I have seen one article on Home Power's Web site about DC generators, but would love to hear from you and others about opinions and experiences with DC generators. Thanks! Regards, Richard Hakim • richard@kokoro.com

Hi Richard, Unless you have dedicated AC loads that you want to also use the generator for, DC generators can be an excellent and efficient choice. I've been using them here for more than a decade. Most of mine have been homebuilt, coupling high-amperage alternators to engines. There have been and are a few manufactured DC generators on the market, and there are military surplus models out there too. Check eBay and around the Web for the DC options—caveat emptor.

Smaller AC generators are more versatile, because you can throw them in your truck to take to another site, and you can run large AC loads directly with them. But a whole-house system should have a large enough inverter to handle all possible loads. If

you don't need mobile AC, the DC generator gets my vote. With an AC generator, you'll need a battery charger as well. Many modern stand-alone inverters have battery charging functionality built into them. Best, Ian Woofenden • ian.woofenden@homepower.com

Hello Richard, Almost all off-grid PV systems use an AC generator for backup. Most larger, off-grid inverters are designed to charge batteries from an AC input (like a generator), as well as produce AC from the energy stored in the battery bank.

I recommend AC rather than DC generators for three reasons:

1. AC generators can provide electricity during construction;
2. AC generators can be serviced locally, and there are lots of models to choose from;
3. AC generators are a backup source for AC electricity if the inverter fails.

Best, Joe Schwartz • joe.schwartz@homepower.com

Acreage for Biodiesel

At some point in the future, I hope to be able to build a home using the many energy saving suggestions you provide. I am curious about biodiesel right now. How many acres of various oil-producing plants (soy, peanut, etc.) would it take to grow my own oil for biodiesel (how many gallons per acre)? The cost of cooking oil is relatively high. Would the oil I produce need cooking-quality refinement? I am thinking about buying a small farm and was looking at self-sufficiency from beginning to end. I would produce the biodiesel required to run tractors, generators for other production, and personal vehicles. I'm wondering if it can be done affordably without a source of free, used oil? I know it's a lot to ask. Thanks for all you do, Chick • b_everett_jr@yahoo.com

Hi Chick, Thanks for writing. Your question is a tough one! As a Peace Corps volunteer in Nepal, I worked with the locals on building water turbines to power the various machines they used to process the foods they grew—rice hullers, grindstones for wheat, and oil extractors. As I remember, it took a long time to extract the oil from the mustard seeds they harvested. It seemed like a very slow process on that small a scale.

But that's not to say that it can't be done. Choosing the appropriate oil crop will be important for you. There are many plants that produce oil and each does well in certain conditions. Depending on where you live, the climate, the soil, and the availability of water, you could grow anything from coconuts (2,070 lb. of oil per acre) to rapeseed (915 lb. of oil per acre) to soybeans (345 lb. of oil per acre) to *Jatropha curcas*, a plant that I just learned of, which contains 60 percent oil by weight. (Check out www.indutourismnews.com/oilextraction.html for more information.)

I'm not a farmer, but maybe a variety of oil crops could be possible—crops that are harvested at different times of the year or crops that perform other functions. For example, coconut palms can be decorative, and *Jatropha* is often used as a security hedge due to its nasty thorns.

I love your idea of creating a self-sufficient farm from beginning to end. But if you want to do that, you might consider running your diesel equipment on straight vegetable oil (SVO) instead of biodiesel. To make biodiesel, you will need methanol, which is pretty difficult to make and expensive to buy. See HP95 for an article on SVO.

I hope the few insights I've provided are helpful. Chick, you are a pioneer, breaking new ground. I'll look forward to the article that you write for Home Power on how you planned and built your sustainable farm, what crops you chose, and how you converted your tractor to run on the oil you produced yourself. Good luck! Scott Durkee • renewable_energy@earthlink.net



Send your questions to Home Power magazine at letters@homepower.com or PO Box 520, Ashland, OR 97520

THERMOMAX™

SOLAR WATER HEATING

IT'S ALL IN THE
V A C U U M

Save up to 80%
on heating bills
Commercial • Residential



25 years
of industry leadership

solarthermal.com

250.721.4360
zev@solarthermal.com
Toll free fax and mess'g
1.888.923.9443
Ask About Dealerships

Technology

Marches On

Richard Perez

©2005 Richard Perez

I answer many questions from *Home Power* readers who are building new off-grid photovoltaic (PV) systems or upgrading their old systems. The two most common questions are—what type of PV charge controller should I use, and what type of inverter should I use? These questions are not surprising since these are the two fastest moving fields in solar electricity, and they are constantly changing.

The information I present here is my personal opinion—the way I would design a system, and the way I have designed my system. I have gathered this information from my own experience, from talking to many PV dealers, and from the experiences of off-grid PV users who read *Home Power*.

PV Charge Controllers

In the old days, PV charge controllers had only one function—to prevent the battery from being overcharged by the PV array. Since the advent of maximum power point tracking (MPPT) charge controllers, this has radically changed for the better. MPPT controllers are one of the greatest advancements in off-grid PV technology in the last twenty years.

Blue Sky's (formerly RV Power Products) Solar Boost charge controllers were some of the first MPPT charge controllers on the market. Richard has two in his system.



All PV modules have what is known as a maximum power point. That is the point where their voltage multiplied by their amperage equals the maximum power. A sad fact of life is that PVs in off-grid systems without MPPT controllers rarely operate at this maximum power point, and often deliver lower power than is possible. This maximum power point is a moving target and is affected primarily by the temperature of the module, but solar irradiance and module age also come into play.

An MPPT charge controller is an electronic device that allows the PV array to operate at its maximum power point even though this point may be many volts higher than the battery voltage. This extracts the maximum output from the array regardless of battery voltage, PV module temperature, solar irradiance, and module age.

The net effect is astounding and continuous—MPPT makes the PVs far more effective. A good analogy for an MPPT controller is the transmission in an automobile, which allows the engine to operate in a narrow and efficient power band while the car's wheels can operate at a wide variety of speeds.

MPPT charge controllers are changing the way we design PV systems. Now it is common to operate a PV array at a higher nominal voltage—often twice the nominal voltage—than the battery bank. This scenario allows for maximum effectiveness of the MPPT, and the maximum amount of energy is extracted from the PV array. It also allows the PV array to be located farther from the battery, since line losses in wiring between the PVs and the battery are lower at higher array voltages.

An MPPT controller works best when there is a coherent maximum power point for it to find. This means that MPPT controllers are most effective when all of the modules they are controlling are of the same brand, type, and age. If the array is composed of differing types of modules, the MPPT controller will still function, but not as effectively as it would if all the modules were identical.

MPPT controllers come in a variety of sizes, from 20 amperes output to more than 60 amperes output. If you have a variety of module types that do not have similar operating characteristics, including maximum power point, group the modules by type and put a separate MPPT controller on each particular array. Here on Agate Flat,



OutBack's MX60 model is the latest addition to Richard's collection of charge controllers.

we use three different MPPT controllers on three differing arrays for this reason.

If you are establishing a new, home-scale system, it makes little sense to use any other type of controller. If you are upgrading your old system, consider rewiring the array for a higher voltage and using an MPPT controller. The additional energy output of your PV arrays will more than compensate for the additional cost of the MPPT controller.

Inverters

After using sine wave inverters here for almost a decade, it amazes me that readers still ask me if they can “get by” with a modified square wave inverter—often referred to as “modified sine wave” by marketers. My response is always, “No.” These folks are attracted by the lower price of the modified square wave inverters.

All 120 VAC appliances are designed to operate on smooth sine wave electricity (just like the grid delivers). While most appliances will function on modified square wave electricity, they will not perform as well, they will be less efficient, and they will have shorter lives.

We operated modified square wave inverters here for more than a decade before the sine wave models became available. We'd never go back. We used to have a “fry-and-die” list posted on the wall by the telephone here. This list contained the makes and models of appliances that would be damaged when operated on modified square wave electricity. The list was extensive—from cordless tool chargers to laser printers. When a reader was considering buying a new appliance, they would give us a call and see if that appliance was on the fry-and-die list. If the appliance was not on the list, we'd tell them to go ahead and buy the appliance (if they dared), plug it into the modified square

wave inverter, and give us a call if it blew up in a cloud of smoke. I can happily say that I don't miss those days, and that we've retired the fry-and-die list.

Just bite the bullet and put a sine wave inverter in your system. The cost of just one major appliance failure will more than likely pay for the added expense of the sine wave inverter. And in addition, all of your appliances will perform better, be more efficient, and last longer.

Once you have decided that sine wave electricity is for you, you will be confronted by a multitude of makes and models to choose from. Use power quality as your prime criteria. First consider the number of steps that the inverter uses to synthesize the sine wave. Some use 50 steps to make a single cycle while others use more than 500 steps. More steps is better because you get a smoother, appliance-pleasing sine wave.

Next consider the voltage regulation (both rms and peak) of the inverter's output. Tighter regulation is better. Then consider the battery charger option offered with the inverter. Switching-type battery chargers often outperform transformer-based models when a standby generator powers them.

Technology Marches On

The advances made in MPPT charge controllers and sine wave inverters can be attributed to the march of electronics technology. This is a fast-moving, dynamic field. I just can't wait for the next round of improvements!

Access

Richard Perez, *Home Power*, PO Box 520, Ashland, OR 97520 • 541-941-9716 • richard.perez@homepower.com • www.homepower.com



LOW ENERGY SYSTEMS, INC. RADIANT AND SOLAR HEATING DESIGN & SALES WITH STATE-OF-THE-ART SOFTWARE SPECIALIZING IN SOLAR/TANKLESS INTERFACING		
STIEBEL ELTRON Solar Collectors & Dual Coil Tanks	WAIWELA Quality Water Heaters by Paloma Tankless Water Heaters	NEW LOCATION 4975 EAST 41 ST AVE. DENVER, CO 80216 1-800-873-3507 SALES@TANKLESSWATERHEATERS.COM
Aeca Solar Differential Controls	VALEN Solar Design & Simulation Software	

	Make every day special The natural ingredients of our products get their energy from the sun
Off the grid since 1980	simmonsnaturals.com 42295 Hwy. 36, Bridgeville, Ca 95526

HYDROELECTRIC SYSTEMS: Pelton and Crossflow designs, either complete turbines or complete systems. Assistance in site evaluation and equipment selection. AC Systems for standalone or grid interconnect operation. Manufacturing home and commercial size turbines since 1976. Send for a free brochure. Canyon Industries Inc., P.O. Box 36 HP, Deming, WA 98244, 360-592-5552. e-mail: citurbine@aol.com web page: canyonhydro.com • HP10602

EARTH SHELTERED HOMES This definitive manual by noted authority Loren Impson features detailed building instructions for amazingly affordable and practical Ferro Cement Domes. Only \$15 from Loren, 71 Holistic, Mt. Ida AR 71957 www.2BbyD.com • HP10603

COSOLAR.COM discount prices from Colorado Solar Electric. OutBack Inverters in stock 1-800-766-7644 • HP10604

SINGLE AND DUAL AXIS SOLAR TRACKER CONTROLS up to 48V and 5A output. www.theanalogguy.com • HP10605

SURPLUS INDUSTRIAL BATTERIES: Save up to 70% on unused military and industrial batteries. Many types and sizes, super H.D. Factory crated. Also chargers, wind and solar equipment, new and used. D.P.S.D. Inc. 3807 W. Sierra Hwy. #6, Acton CA 93510. 661-269-5410. Fax 661-269-3601. • HP10606

RADIO/TELEPHONES Voice-Fax-Web 1-8 lines 20mi. CELLULAR Antenna pkg improves access 208-263-9755 PDT • HP10607

VIDEOS AVAILABLE: NEW-"GUERRILLA SOLAR INSTALL", "Introduction to Solar Electricity", "Introduction to Solar Pool Pumps", "How To Solar Installation Video" VHS and DVD www.igotsolar.com • HP10608

SOLARHARDWARE.COM Best prices guaranteed • HP10633

ECOMALL: The largest environmental portal of earth-friendly companies and resources. Renewable energy companies, news and information. www.ecomall.com. To advertise, call 845-679-2490. • HP10609

LARGE GAS REFRIGERATORS 12, 15 & 18 cubic foot propane refrigerators. 15 cubic foot freezers 800-898-0552 Ervin's Cabinet Shop, 220 N County Rd. 425E., Arcola, IL 61910 • HP10610

XXXXXXXXXX UNI-SOLARXXXX
XXXXXXXXXX 64 Watts \$319 XXXXXXXX
New 105AH AGM 12V batteries-Reg \$185, Sale \$75. TraceX SW2450 (GTI unit) \$1995. Ex 2KW inverter SB \$850. Buy, sell New/Used 760-949-0505 • HP10611

HONDA GENERATORS - 1000 to 10,500 watts. Fast shipping and great prices! www.hayesequipment.com 1-800-375-7767 • HP10612

DC SUBMERSIBLE WELL PUMPS. Complete, ready to install. \$187 includes IMMEDIATE FREE SHIPPING. Visit www.nemosolar.com or call 1-877-684-7979 • HP10613

I AM A SOLAR WHOLESALER looking for retailers to carry my solar electronic and hobby goods. Phone # (916) 486-4373. Please leave message. • HP10614

TELLURIDE COLORADO: Off the Grid Properties! Hot Springs, Riverside, solar powered homes, large and small ranches. Find your own place in the sun with the only solar powered real estate office in Colorado. T.R.I. (970) 728-3205 1-800-571-6518 www.solarrealty.net • HP10615

EDTA RESTORES SULFATED BATTERIES. EDTA tetra sodium salt, \$12/lb. plus \$5 S&H for 1st lb. plus \$1 S&H for each additional lb. Trailhead Supply, 325 E. 1165 N., Orem, UT 84057, (801) 225 3931, email: trailheadsupply@webtv.net, info. at: www.webspawner.com/users/edta. • HP10616

WE HAVE HARD TO FIND SOLAR ELECTRIC PRODUCTS. Panels, photovoltaic inverters & more. Discover Power for Free Catalog. www.discoverpower.com 1-800-842-5678 • HP10617

SOLAR HEATERS FOR SALE! Get free heat from the sun for your home, office, garage, etc. Visit us today at www.hotboxsolar.com or by phone at 1-607-481-0992. HotBox Solar. 263 Glenwood Ave. Elmira Heights, NY. 14903 • HP10618

VARI-CYCLONE: DC powered ceiling fan, 40% more airflow with no increase in power consumption. For more info contact RCH Fanworks, the #1 manufacturer of DC powered ceiling fans, 2173 Rocky Crk. Rd. Colville, WA 99114 PH: 509-685-0535, email: info@fanworks.com, Web: www.fanworks.com, Dealer inquiries welcome. • HP10619

SURVIVAL UNLIMITED.COM - Emergency Preparedness & Survival Supplies. Wind Power from 439.00+. Many great products & prices! 1-800-455-2201 www.survivalunlimited.com • HP10620

CONVERT WOOD TO ELECTRICITY: Complete 7 KW 120/240VAC steam engine powered generator sets ready to run. steamgen@juno.com www.geocities.com/steamgen 918-520-7711 • HP10621

WWW.EARTHTOYS.COM - Online library and emagazine all about alternative energy systems and equipment • HP10622

Huge \$ savings **SURPLUS AGM BATTERIES** fully reconditioned and tested. Recondition your batteries, eliminate water loss, and gassing. Save BIG \$'s and extend the life of your batteries. Call Tim Ivie 661.609.1069 or visit www.hyperpowerusa.com • HP10623

WIND FARM DEVELOPMENT for Farmers and Landowners. 1 or more turbines www.techlinepower.com 414-374-0021 • HP10624

SUN CHART SOFTWARE. For positioning solar collectors. www. VisualSunChart.com • HP10625

2 COMPLETE BRIGHT RED SOUTHWEST AIR 403 WINDMILLS. Best offer 888-239-9890 • HP10626

50+ MICROHYDRO TURBINES plastic & stainless, Brass Nozzles 5-29mm, Arbors, Site study tools, J Hartvigsen, 1529S 400E Kaysville UT 84037 http://h-hydro.com • HP10627

BERGEY 850 WANTED Blades or complete system. emillio@fastmail.com 802 342 0745 • HP10628

WHITE-LED SOLID-STATE LIGHTING. Why waste the energy you work so hard for? AlbEO's manufactures lighting that is stylish, environmentally friendly, and saves \$'s. Visit www.albeotech.com • HP10629

FOR SALE: 40' 1998 SERENGETI MOTORCOACH as showcased in Home Power issue #75. Please contact David Barton at 713-818-7752 or email him at barton_dp@yahoo.com • HP10630

FOR SALE: ZOMEWORKS SELF TRACKING RACKS-NEW \$300 each, \$550 both-OBO. 206-841-1964 • HP10631

COMPLETE OTG SYSTEM 8KW DIESEL, tank, Trace 4024 inverter, rack, panels, batteries etc. in Utah, bobanddenna@msn.com • HP10632

WANT TO LIVE RENT-FREE - anywhere in the world? There are empty homes, some solar powered and off-grid, in every state and country, and property owners are looking for trustworthy people to live in them! The Caretaker Gazette contains these property caretaking/housesitting openings. Published since 1983, subscribers receive 1,000+ property caretaking opportunities each year, worldwide. Some of these caretaking and housesitting openings also offer compensation in addition to the free housing provided. Subscriptions: \$29.95/yr. The Caretaker Gazette, PO Box 4005-E, Bergheim, TX 78004. (830) 336-3939. www.caretaker.org • HP10634

ENERTECH 4 KW & 4 KW W/ 5KW GENERATOR for sale, \$400 & \$450 or \$800 for both. Need blades and rebuild. robert@AbundantRE.com (503) 538-8298 • HP10635

JAKE 3.6 KW HIGH VOLTAGE WIND GENERATOR with WindyBoy grid connect inverters. Remanufactured Jakes with new blades and governor. Tilt down 80' tower available. Only 2 available. Order now for spring delivery. Also Jake parts available. robert@AbundantRE.com. (503)538-8298 • HP10635

MOVE TO BEAUTIFUL, SCENIC N. IDAHO! We have many alternative energy homes to choose from. www.maidenrock.com Maiden Rock RE Sandpoint, ID 1-877-428-7370 • HP10636

HYDRO-ELECTRIC PLANT-All components 24V, all hi-qual. Trace eqt 208-476-4684 • HP10637

NEED CUSTOMER SERVICE TECHNICIANS. If you have the experience to answer very technical and challenging questions about our products and are willing to re-locate to Arlington Washington, we have two positions open. We require self starters that will live up to the standards that our customers have grown to expect. Apply by e-mail to: rgudgel@outbackpower.com • HP10638

LIVE THE DREAM Self-sufficient homestead on 35+ acres in E.WA. Solar power home, orchard, garden, berries, grapes, etc. jstan@televar.com • HP10639

SOLAR BATTERIES Absolyte Telecom PV Batteries (100-A series) maintenance-free, non-gassing, freeze-tolerant, priced comparable to lead acid. 866-SOLAR-99 www.solarunlimited.net • HP10640

SOLAR HOT WATER SYSTEMS: Manufacture - Sales - Service. 6772-99 St Edmonton AB CAN 780-466-9034 www.trimlinedesigncentre.com • HP10641

TRACE (XANTREX) DR SERIES INVERTER/CHARGER V3.2. PPDR3624SBC1040 (3600 watt power panel) Serial #AD08596 SO45436. Best offer, call for details. 719-544-7036 • HP10642



Readers' Marketplace Rates

Rates: 25¢ per CHARACTER, include spaces & punctuation. \$20.00 minimum per insertion. All Readers' Marketplace ads are published in both the print and Web versions. Please send a check or Visa, MasterCard, American Express, or Discover card data with ad. Please, no money orders. We do not bill Readers' Marketplace ads; they must be paid for in advance of publication. Your cancelled check or credit card bill is your receipt.

Submit your ad by:

- **E-mail:** (preferred) readersmarketplace@homepower.com;
- **Fax:** 541-512-0343;
- **Phone:** 800-707-6585 or 541-512-0201

Help us prevent fraud! *Home Power* Readers' Marketplace ads from individuals must supply serial number(s) for equipment being sold. Businesses must supply published phone number(s) and a physical address. While *Home Power* is doing everything we can to prevent fraud, we can assume no responsibility for items being sold.

installers directory

Do you want a renewable energy system, but don't want to install it yourself? You deserve a system that meets your expectations and budget! A renewable energy professional will design and install a safe, code-compliant system, and offer you service and support after the sale. Check out the state-by-state installer listings below.

Home Power does not guarantee the quality provided by the businesses listed below—please shop carefully, request references and certifications, and compare.

Alaska

Remote Power Inc.

Remote Power Inc., Greg Egan, President. Licensed electrician since 1982. Outback certified field service technician. MREA trained wind system installer. Design, installation, sales & service of wind, pv, & hydro systems. We have affiliated installers statewide. Bush jobs no problem. We stock inverters, PV panels, efficient appliances, etc. at our shop near Fairbanks. Call 1-888-257-3639 or 1-907-457-4299

Arizona

www.gswpowersystems.com

Generator Solar & Wind Power Systems Design, Sales, installation & maintenance. Off-grid & grid-tied, prime power or back-up. Complete systems, hybrid systems, or sub systems & components. We can do it. Covering all of Arizona & dedicated to helping all present & potential customers. Ralph Odonal, license # ROC203166. (928) 639-2297, (928) 300-4067, altpwrsys@hotmail.com



Good Power Company, Stand Alone or Grid Tie systems for homes, business, solar wells and outdoor lighting. Solar, wind and motor generator systems. Licensed contractor serving ALL of Arizona. Remote home specialist! Free estimates. Call Dave Haycock for prompt courteous design, sales, installation and service. (520) 560-3856, espdave@hotmail.com. References. ROC195768

California



Acro Electric is a full service, turn-key, res. & comm. solar electric contractor. We design, install, & handle all necessary CEC, utility forms and contracts. Quality installations are backed by 31 years experience. Approved by the League of California Homeowners (www.homeowners.org) & Better Business Bureau (www.midcalbbb.org). Free site analysis & brochure. (209)847-2977 • www.acroelectric.com



Akeena Solar is the nation's largest residential solar electric installer with two NABCEP-Certified PV Installers on staff. Our design/build services coupled with our complete financial analyses, based on actual site conditions, support our growing list of satisfied customers in making the switch to clean reliable energy. Serving CA, NJ, MA, RI, CT, & NY. Visit www.akeena.net or call 888-akeena-8



Carlson Solar. has been serving Southern CA since 1988. We are a licensed, bonded, and insured solar-electric installation company, specializing in both grid-tie and off-grid systems. We are NABCEP certified and take great pride in our excellent customer service. Saving the environment one house at a time. Call toll-free 1-877-927-0782 or visit us at www.carlsonsolar.com



Cobalt Power Systems Inc. is a full-service, licensed installer of PV systems in the SF Bay Area. We offer free consultations, detailed proposals, professional system design by an electrical engineer, expert installations, and competitive pricing. We handle all the paperwork for the client, and we oversee all inspections. Please contact us at 650-948-9574 or www.cobaltpower.com.

Eco-Energies

EcoEnergies is recognized as Northern California's leading Renewable Energy Experts. We specialize in Solar Electric, Cogen, and Wind powered systems. Our entire engineering staff is NABCEP certified and dedicated to unparalleled quality, customer service and customized solutions. Start saving Your Money while saving Your world! Call for Free Estimate 1.866.765.9463

California, cont.



Electron Connection Licensed in CA and Oregon. NABCEP Certified installer. Serving northernmost California and southern Oregon. PV, wind, microhydro installs. (800) 945-7587 email: bob-o@electronconnection.com, www.electronconnection.com



Empower Energy, Southern CA. We design, sell, install, & service high quality residential & commercial solar, wind, & hydro systems. Specializing in grid-tied & remote stand alone systems in any part of CA. Make renewable energy a part of your home, ranch, or business. Lic. in CA since 1995, (#711993). Cert. SMA & Sharp installer. 818 222-8700, toll free 800 494-2366, EmpowerEnergy.net, Info@EmpowerEnergy.net



Feather River Solar Electric Bill Battagin of Taylorsville has been designing, installing and servicing renewable energy systems since 1982. PV, micro-hydro, hybrids; grid intertie or stand alone systems. CA Elect.l Lic. # 681552, Outback Cert. Tech. We live and work with RE. Serving Plumas, Lassen, Sierra, Butte Cos. 530.284.7849 frenergy@psln.com, www.freenergy.net



NABCEP Certified

Offline Independent Energy Systems, Since 1983. An electrical contracting co., we specialize in utility intertie (with state rebate & net metering) & off grid systems. Owned & operated by Don & Cynthia Loweburg in Central CA East of Fresno. We run our home & business with solar electricity. POB 231, North Fork, CA. 93643, (CA lic# 661052) ph 559 877 7080, fx 559 877 2980, ofln@aol.com www.psnw.com/~ofln



Owens Electric & Solar, Providing quality power solutions since 1964. Full range of energy conservation & turnkey services including efficiency upgrades & PV solar system installations for residential & commercial applications. Licensed, bonded, certified, & insured C-10 Electrical Contractor (#464389) serving northern CA. 1-877-57-SOLAR. info@owenselectricinc.com www.owenselectricinc.com



Sky Power Systems, provides affordable solar electric solutions, residential & commercial. NABCEP certified installer. Quality, 100% turnkey, affordable installations. Special pricing & design/installation advice for DIY. CEC rebates; long-term, 100% financing available. Free \$\$ analysis & site evaluations, toll free (CA only) 888-41SOLAR (888-417-6527), www.skypowersystems.com, Lic. # 800947, Bonded & Insured.



Solar Wind Works specializes in consultation, sales, design, service, & installation of complete RE systems. US Distributor for Proven Wind Turbines. We supply all components necessary for a complete, efficient, system—Grid-connected or grid-independent. POB 2511, Truckee, CA 96160, 530-582-4503, Toll Free: 877-682-4503, NABCEP Certified chris@solarwindworks.com, www.solarwindworks.com

Canada



Energy Alternatives has been serving Canadians for over 20 years. A licensed electrical contractor (BC Lics # 86683) with professional installers throughout Canada. Expert consultation & design services, turn-key installed systems or DIY packaged system kits. Extensive inventory for fast delivery. Visit www.EnergyAlternatives.ca, Call 1-800-265-8898. Canadian dealer inquiries welcome.

Colorado



Burnham-Beck & Sun, Solar & Wind Energy Systems. Located in Fort Collins, Colorado, we make site evaluations, system designs, and installations in Northern Colorado, Southern Wyoming. We drop-ship equipment anywhere in the US. Retail products include PV modules, wind turbines, inverters, batteries, efficient appliances. 970-482-6924. mailto: BurnhamBeckSun@aol.com. www.burnhambeck.com



Solar Solutions Ltd. provides photovoltaic, wind & hybrid power systems & components for stand alone systems, grid tied, RV's & remote water pumping. Committed to providing the highest quality service & customer satisfaction. A proud member of Colorado SEIA and a lifetime member of the Colorado RE Society and ASES. Xantrex Certified Dealer. 888 44solar or 888 447-6527 www.solarsolutions.com

Florida



ECS Solar Energy Systems (tel) 352-377-8866 www.ECS-solar.com / tom@ECS-solar.com We service FL, the Caribbean and the Southeastern U.S. FL's first solar contractor since 1977. Solar pool heating, hot water, and electric systems -commercial & residential. Solar lic. # CVC056643 Florida state certified for "grid-connected" systems. Contact us now to receive a free solar informational booklet.

Mexico



SC Solar designs/install PV systems—residential, US military, solar lighting, water pumping, traffic management power systems. Solar thermal & micro hydro. Custom UPS systems for off grid. Installation area: NC, SC, VA, GA, TN, & Mexico. For more info & credentials: 803-802-5522 www.scsolar.com CCR# & Cage Code #1SLJ5.

Michigan



Backwards to the Future Ltd., installing, designing and supplying solar equipment since 1986. OEM supplier of evacuated tube heat pipe technology for DHW & hydronic heating. Systems building integration by joint venture with registered architect. State licensed residential builder & solar mechanical contractor. POB 409 Fennville MI 49408 tel: 269 2366179 email: info@BTFsolar.com www.BTFsolar.com

Montana



Planetary Systems, Inc. In business 10+ years. Sales/design/installation of complete RE electrical, water & hydronic heating systems. Our patented RE "Power Package" simplifies installation & reduces costs. Can be shipped nationwide & installed locally. CAD schematic system drawings/technical support provided. Xantrex Certified Dealer. Phone (406) 682-5646, www.planetarysystems.com

Nevada



Alternative Energy Solutions, Reno, Nevada. We design, sell, install and service PV, wind, off grid and grid tie RE systems, Nevada State Licensed and Bonded Contractor, NABCEP PV Certified Installer. Xantrex / Trace Authorized Service Center, Xantrex Certified Dealer, Outback Factory trained field service technicians and Certified Uni-Solar field laminate installer. 775-857-1157 toll free 1-866-491-SOLR



Solar Unlimited, Inc. serves Nevada's Renewable Energy design, sales, service, and installation needs, including PV, wind, net-metering and off-grid systems. We are authorized dealers for Solarwall, Gillette, Xantrex, Outback, African Wind Power and more. Licensed and insured. Call toll free 866-SOLAR99 or visit www.solarunlimited.net.

New Hampshire



Sunweaver Incorporating innovative technologies for power, water and heat. Encouraging knowledge and direction towards resource responsible solar living. Installing in New England and the Caribbean since 1985. www.sunweaver.org. mailto: info@sunweaver.org 603-942-5863 Showroom hours: Monday-Saturday 11am-6pm

New Jersey



Akeena Solar is the nation's largest residential solar electric installer with two NABCEP-Certified PV Installers on staff. Our design/build services coupled with our complete financial analyses, based on actual site conditions, support our growing list of satisfied customers in making the switch to clean reliable energy. Serving CA, NJ, MA, RI, CT, & NY. Visit www.akeena.net or call 888-akeena-8

New Mexico



Positive Energy Inc. High quality renewable power systems. Licensed, bonded, and insured electrical contractor serving Santa Fe and northern NM. Owner Allan Sindelar is NABCEP certified and is a certified dealer/installer for Xantrex, Outback, and Sunnyboy. 505 424-1112. E-mail: info@positiveenergysolar.com. Website: www.positiveenergysolar.com



Direct Power and Water Corp designs, engineers and professionally installs turn-key solar electric systems for remote homes/log cabins, commercial, telecommunication, and water pumping applications. Our staff Design Engineer Daniel Duffield & Master Electrician EE98J Dave Hammack have over 30 years experience and live by PV. References provided. Contact us @ (800)260-3792 www.directpower.com

New York



Daystar Energy Systems We're making it easy to choose renewable energy. Unparalleled pricing guarantee, exceptional installation service, and backed up with a comprehensive warranty. Not your average installer, ask about our Sweat Equity and Referral Incentive Programs. Putting customers first in NY and NJ. Call Desi 585-224-9105 www.daystarenergysystems.com



Solar & Wind FX Inc. NY's only Off-grid Design & Training Center, where a client can see the latest RE & Green building technologies. A family owned, full service company focusing on Western NY that provides site evaluation, design, installation & the all important, service after the sale. Member of NESEA & NYSEIA, SEI alumni & a NYSEIDA installer. 585-229-2083, solarandwindfx.com



Suntric Renewable Electric Systems, Experienced, qualified installers of photovoltaic, wind, and micro-hydro stand alone systems. Located on the western end of the Adirondack Park in northern New York State. Site evaluations, design consultations, sales and service. Off grid since 1976. Edwin & Pamela Falk, 6920 Abbey Road, Lyons Falls, New York 13368 • 315-348-6893

North Carolina



Solar Village Institute, Inc. NC's premier solar, wind, micro-hydro dealer-installer-educators. Off-grid since 1992. Top quality, pro work, guaranteed. NC, SC, VA, GA, AK. Specializing in Wind/Solar hybrid off-grid systems. New/remodels. Christopher W. Carter, Pres. SEI alumni, Xantrex Cert. dealer. David Del Vecchio, installation manager. www.solarvillage.com, chris@solarvillage.com, 800 376 9530

Ohio



Third Sun Solar & Wind Power, Ltd. is Ohio's leading renewable energy contractor. Complete design and installation of off-grid, utility tied, PV and wind systems in OH, KY, IN, IL, MI, PA, WV. Owner Geoff Greenfield is NABCEP Certified Solar PV Installer. We are committed to excellent customer service & the highest quality systems. www.third-sun.com. (740) 597-3111.

Oregon



Electron Connection Licensed in CA and Oregon. NABCEP Certified installer. Serving northernmost California and southern Oregon. PV, wind, microhydro installs. (800) 945-7587 email: bob-o@electronconnection.com, www.electronconnection.com



Mr. Sun Solar: Since 1980, the Northwest's leading solar installer. Over 1,200 projects including solar hot water, solar pool heating, solar attic fans, and on- and off-grid PV systems. Dealer for Sol-Reliant™, The Solar Water Heater Built to Last - OG-300 and Bright Way™ approved. Phone: (888) SOL-RELY (888-765-7359). Web: www.MrSunSolar.com and www.SolReliant.com



Solar/wind Power of Portland, and our partner, Inland Electric, installers of solar electric & hot water systems, wind power, & solar shades, serving the Portland/Vancouver Metro area. Oregon Energy Trust ID #10012. Free information packet, or visit our showroom: 10006 SW Canyon Rd., Portland, OR 97225. Phones: 503/297-5781, or 800/550-2950. WEB: www.solarwindpdx.com, solarwind@ecosky.com.

Pennsylvania

www.
windturbine-1
.com

Appalachian Wind Systems, LLC has been serving PA, WV & MD for 6 years. Distributor for Cyclone wind turbines, Synergy wind turbines, Sun solar panels, LED lighting, stand alone & grid tie inverters and other products. Site evaluations and financial analyses. We also sell, service & install 10–60 meter NRG meteorological towers & first stage wind analysis. For more information, call 724-452-0326

South Carolina



SC Solar designs/install PV systems—residential, US military, solar lighting, water pumping, traffic management power systems. Solar thermal & micro hydro. Custom UPS systems for off grid. Installation area: NC, SC, VA, GA, TN, & Mexico. For more info & credentials: 803-802-5522 www.scsolar.com CCR# & Cage Code #1SLJ5.

Texas



Meridian Energy Systems specializes in the design and installation of high quality solar and wind energy systems throughout the State of Texas...and beyond. Factory trained technicians and NABCEP Inaugural Certificiant on staff. Visit our website www.meridiansolar.com or call toll-free: 888-477-3050



North Texas Renewable Energy Inc. North Texas' premier solar and small wind energy service. Complete system design and installation. Available service contract Independence–Reliability–Conservation. Jim Duncan answers@NTREI.com 817.917.0527

Utah



Solar Unlimited, Inc. Southern Utah's leading design, sales, service and installation professional for all your alternative and Renewable Energy needs, including PV, wind, net-metering or off grid systems. We are authorized dealers for Solarwall, Gillette, Xantrex, Outback, African Wind Power and more. Licensed and insured. Call toll free 866-SOLAR99 or visit www.solarunlimited.net.

Vermont

Independent
Power

Independent Power serving Northern Vermont since 1988. David Palumbo designs, sells, and installs solar electric systems. NABCEP Certified installer, Outback Power Certified Field Service Tech. Specializing in efficient off grid homes. Phone: 802-888-7194, e-mail: IP&L@sover.net, www.independent-power.com



Vermont Solar Engineering has provided the finest in renewable energy throughout New York and New England, since 1991. We design, install, and support solar electric, wind electric, and solar hot water systems. K. Herander, NABCEP™ certified installer. Xantrex Certified Dealer. NYSERDA eligible installer. Vermont Solar and Wind Partner. www.vermontsolar.com 1-800-286-1252

Virginia



Dunimis Technology Inc. Providing alternative energy systems since 1992. NABCEP certified solar technicians on staff. We specialize in the more demanding upscale off-grid residential & commercial installations. Installations completed in ID, TX, PA, NJ, NC, VA, and WV. P.O. Box 10, Gum Spring, VA 23065, Phone 804-457-9566, jryago@wwjv.net., www.pvforyou.com

Washington



Mr. Sun Solar: Since 1980, the Northwest's leading solar installer. Over 1,200 projects including solar hot water, solar pool heating, solar attic fans, and on- and off-grid PV systems. Dealer for Sol-Reliant™, The Solar Water Heater Built to Last - OG-300 and Bright Way™ approved. Phone: (888) SOL-RELY (888-765-7359). Web: www.MrSunSolar.com and www.SolReliant.com



Power Trip Energy Corp. "Craft Your Personal Energy Policy" Electrical contractors specializing in renewable energy & a holistic approach to your power needs incorporating complete wiring packages & efficiency analysis. We serve all of Washington, grid-tied & off-grid, residential & commercial. www.powertripenergy.com, (360) 643-3080, info@powertripenergy.com, WA Cont # POWERTE964JN.



SolarWind Energy Systems, LLC P.O. Box 1234, Okanogan, WA 98840 (509) 422-5309 www.solar-wind.us WA Cont. # SOLARES983RQ. Serving Eastern WA & Northern ID grid-tied & off-grid RE systems. Solar PV, wind, solar hot water, remote stock watering. Design, installation, service, maint. Solar Energy International (SEI) trained. Lic. & bonded. bclark@solar-wind.us or jmartin@solar-wind.us



Sound Power Design • Site Surveys • Installation • Service. Contractor Reg. # SOUNDPI983NW www.soundpower.us phone 425-844-8748 fax 425-844-8928 Licensed, bonded, insured electrical contractor. Renewable energy specialist. We will travel anywhere in Washington to install PV, wind, and microhydro systems.

Wisconsin



Great Northern Solar, In business since 1988. NABCEP certified. "Waking the Northland to renewable energy & sustainable living!" We install PV, wind and microhydro systems. Large focus on education—workshops on residential and commercial installations available. MREA instructor. Chris LaForge at 715 774-3374, email: gosolar@cheqnet.net 77480 Evergreen Rd Ste #1 Port Wing, 54865

Photovoltaic
Systems Co.

Photovoltaic Systems Co., since 1980 we have been designing, installing and servicing solar electric systems statewide in wi. NABCEP certified, Xantrex certified dealer & authorized service cntr.; MREA instructor teaching basic thru advanced PV systems workshops. James Kerbel 7910 hwy 54 Amherst Wi. 54406 715-824-2069 PVSOLAR@wi-net.com

adopt a library!



When Karen and I were living with kerosene lamps, we went to our local public library looking for a better way to light up our nights. We found nothing about small-scale renewable energy. As a result, one of the first things we did when we started publishing *Home Power* sixteen years ago was to give a subscription to our local public library.

If you'd like to do the same for your public library, we'll split the cost of the subscription with you. Inside the U.S., you pay \$11.25 and we'll pay the rest. Outside the U.S., the same offer stands, so call us for rates.



— Richard Perez, Publisher



Original Magazine Layouts & More

Searchable • Exportable • Printable • Acrobat PDF®

Shipping: \$2 US, \$3 CAN, \$4 INT

\$25 each when you buy four or more. Full set (9) for \$190—a \$71 savings!

Order online at www.homepower.com or call 800-707-6585 or 541-512-0201

\$29
each

Solar9: Issues #95–100 (June '03–May '04)

Home Power's newest CD-ROM features our milestone 100th issue! Includes spreadsheets for load analysis and wire sizing; U.S. solar and wind resource data; our new renewable energy glossary; and more.

Solar8: Issues #89–94 (June '02–May '03)

Features enhanced navigation. Includes spreadsheets for load analysis, wire sizing, and the Energy Master for system design; 30 years of solar insolation data & wind data for 900 U.S. sites; manuals and spec sheets of popular RE equipment; and much more.

Solar7: Issues #83–88 (June '01–May '02)

Includes spreadsheets for load analysis, wire sizing, and the Energy Master for system design; classic introductory articles from the *HP* archives; 30 years of solar insolation data & wind data for 900 U.S. sites; bonus video clips in QuickTime video format; and much more.

Solar6: Issues #77–82 (June '00–May '01)

Includes spreadsheets and tools for system design; classic introductory articles from our archives; solar insolation & wind data; and much more. **PLUS, a second CD** featuring the *Energy Pathways* video on the basics of renewable energy.

Solar5: Issues #71–76 (June '99–May '00)

More than 1,400 pages of *Home Power*; guerrilla solar video clip; five hours of audio lectures (MREF '99) on batteries, inverters, ram pumps, etc.; spreadsheets for load analysis, wire sizing, and system design; 30 years of solar insolation data; and much more.

Solar4: Issues #61–70 (October '97–May '99)

More than 1,200 pages of *Home Power*; three hours of audio lecture (MREF '98) on batteries, inverters, and RE system Q&A; video clips from the "RE with the Experts" series; spreadsheets for load analysis, wire sizing, and system design; and much more.

Solar3: Issues #43–60 (October '94–September '97)

More than 2,000 pages of *Home Power*; two hours of audio lecture on batteries and inverters (MREF '97); spreadsheets for load analysis, wire sizing, and system design; an interactive tour of the original *Home Power* facilities; and much more.

Solar2: Issues #1–42 (November '87–September '94)

Contains More than 3,900 pages of *Home Power*. Navigate easily among the gems of *HP's* roots, and reconnect with the original authors and timeless features that established the unrivaled "Hands-On Journal of Home-Made Power."

Solar1: Renewable Energy Basics

Fifteen years of *Home Power* introductory articles on one CD-ROM. Organized into fifteen topical categories, there's no better resource for those new to renewable energy. See www.homepower.com for a complete table of contents.

- | | | | |
|-------------------------------------|-------------------------------|---|-----------------------------|
| AAA Solar Supply 103 | Earthwood Building School 90 | MREA Workshops 59 | Solartrax Power Stations 91 |
| ABS Alaskan 59 | EcoEnergies 102 | National Solar Supply 66 | Solectria Renewables 25 |
| Advanced Communication Solutions 70 | Electro Automotive 90 | New Society Publishers 112 | SOL-Solar-On-Line 98 |
| Advantage Solar 79 | Electron Connection 43 | North American Board of Certified Energy Practitioners 94 | SolWest RE Fair 87 |
| AEE Solar Supersource 4 | Energy Outfitters 7 | North Carolina Small Wind Initiative 40 | Southwest Solar 103 |
| Affordable Solar 20 | Energy Systems & Design 59 | Northern Arizona Wind & Sun 73 | Southwest Windpower 35 |
| All Battery Sales & Service 33 | Forcefield 105 | Northwest Energy Storage 66 | SPS Energy Solutions 71 |
| Alternative Energy Store 102 | Fronius International 21 | Offline 98 | Staber Industries, Inc. 58 |
| Alternative Power & Machine 105 | Gorilla Vehicles 89 | OutBack Power Systems IBC | Sun Electronics 50, 103 |
| Apollo Solar 33 | Harris Hydroelectric 72 | Permaculture Credit Union 99 | Sun Festival Southwest 86 |
| B.Z. Products 91 | Heliodyne 99 | Planetary Systems Inc 70 | Sun Frost 67 |
| BackHome 102 | Home Power Back Issues 81 | PV Powered 32 | Sun Pumps 67 |
| Backwoods Solar Electric Systems 42 | Home Power CD-ROMs 127 | Quick Start Specials 80 | Sun Spot Solar 105 |
| Bailey's Inc 95 | Home Power Solar1 CD-ROM 81 | Radiantec 40 | SunDanzer 71 |
| BioShield 107 | Home Power Sub Form 81 | Rae Storage Battery Company 113 | SunEarth Inc 78 |
| Blue Sky Energy Inc 91 | Home Power T-shirts 80 | Rainier Yurts 40 | SunWize 42 |
| Bogart Engineering 41 | Homepower.com 116 | RightHand Engineering 19 | Surette Battery 99 |
| BP Solar OBC | Hutton Solar 65 | Rolls Battery Engineering 51 | Thermomax 119 |
| Brand Electronics 95 | Hydro Induction Power 102 | San Juan College 107 | Thermomax & Thermo Tech 65 |
| BTF Ltd 49 | Hydrocap 71 | Simmons 121 | Trojan Battery 35 |
| Butler Sun Solutions 58 | Hydroscreen Co LLC 91 | SMA America Inc 2 | U.S. Battery 5 |
| C. Crane Company 64 | Independent Energy Systems 72 | Solar Converters 51 | UniRac 72 |
| Canyon Industries 95 | Independent Power Systems 25 | Solar Depot IFC | Vena Engineering 73 |
| CheapestSolar.com (ZAP) 70 | Inverter Service Company 33 | Solar Electrical Systems 58 | Wattsun (Array Tech Inc) 49 |
| Colorado Solar Electric 102 | KTA Services Inc 89 | Solar Energy International 34, 105 | Wind Turbine Industries 73 |
| Communities magazine 103 | Kyocera Solar Inc 6 | Solar Living Institute 117 | Windstream Power Systems 98 |
| Dankoff Solar Products 41 | Low Energy Systems 121 | Solar Log Home for Sale 59 | Writing for HP 113 |
| Daystar Inc 105 | Matrix Solar Technologies 116 | Solar Pathfinder 49 | Xantrex 1 |
| Direct Power & Water Corp 79 | Midwest RE Fair 85 | Solar Wind Works 78 | Zephyr Industries Inc 113 |
| Earth Solar 11 | Mike's Windmill Shop 113 | SolarFest 90 | Zomeworks 95 |
| | MK Battery/East Penn Mfg 24 | | |
| | Morningstar 67 | | |



Coming Next Issue:

- **Solar Hot Water Systems Simplified—The Perfect Intro**
- **Hot Stuff! Check Out Your Solar Cooking Options**
- **Gearing Up to Make Your Own Biodiesel**
- **On the Zero Energy Path—How Low Can You Go?**

Also next issue—Mercey Hot Springs builds a geothermal heat exchanger to capture and use the abundant heat energy at their site.

homepower

The Hands-On Journal of Home-Made Power

Issue 106

April & May 2005

Surf, Sand & Solar

An Off-Grid Island Getaway in the Florida Keys p. 12

Portable, Packable Power

E-Mail on the Road or in the Wild p. 68

Weekend Solar Project

Backyard Fountain, Step-By-Step p. 60

Build Smart, Build Fast!

With Structural Insulated Panels p. 36

Cutting-Edge
GEAR
8 great
inverters

p.26

homepower.com

\$6.95 US \$10.95 CAN



Display until June 1

SOLAR CONTRACTORS: take a good look at



LOWER PRICES



Established 1979

**WE SUPPLY
GRID-TIED AND
OFF-GRID SYSTEMS**

*ONE OF THE LARGEST
INVENTORIES IN THE U.S.*

*PRODUCT DELIVERY
FROM THREE LOCATIONS
TO YOUR JOB SITE*

*PREPACKAGED
ENGINEERED RESIDENTIAL
SYSTEMS*

*DESIGN ASSISTANCE
FOR COMMERCIAL PROJECTS*

*ASSISTANCE WITH
REBATE FILING*

*EXPERIENCED ENGINEERS
AND MASTER TECHNICIANS*

**25 YEARS OF EXPERIENCE
AND STAYING POWER**



**HOMEOWNERS CALL
US FOR THE NAME OF THE
NEAREST SOL-GEN
CONTRACTOR**



HUGE INVENTORY



MORE LOCATIONS



TIMELY DELIVERY



DESIGN ASSISTANCE



BETTER TECH SUPPORT



REBATE ASSISTANCE



xantrex
Smart choice for power
AUTHORIZED DISTRIBUTOR

OutBack
Power Systems
AUTHORIZED DISTRIBUTOR

SOLAR DEPOT - PETALUMA
1240 HOLM ROAD
PETALUMA, CA 94954
707.766.7727
FAX 707.766.7722
ORDER LINE 800.622.4041

SOLAR DEPOT - SACRAMENTO
8605 FOLSOM BLVD
SACRAMENTO, CA 95826
916.381.0235
FAX 916.381.2603
ORDER LINE 800.321.0101

SOLAR DEPOT - CORONA
1520-H COMMERCE ST.
CORONA, CA 92880
951.737.7652
FAX 909.737.7630
ORDER LINE 800.680.7922

www.solardepot.com



bp solar
Distributor

Calling the OutBack PS1 JUST A Grid-tie Inverter isn't fair...

Complete Power System

The PS1 includes a 3 kW grid-tie inverter, battery charger, AC transfer switch, MPPT controller, ground fault protection, disconnects, manual bypass, load breakers and all internal wiring.

High Performance

The PS1's power production is comparable to other's batteryless PV inverter systems, but it provides the benefit of backup power during utility outages from both the PV array and from maintenance free sealed batteries - day or night.

Easy To Install

The PS1 comes prewired, tested, ready to go. All battery and inverter cables are included. Even the mounting holes are located on 16 inch centers to save time.

Adaptable

The PS1 includes spaces for optional PV sub-array input breakers and AC load output breakers - eliminating the need for additional conduit, wiring and breaker panels in most installations.

Listed and Proven

From the PS1's outdoor rated rainproof enclosure to the ETL listing and standard 5 year warranty - the OutBack PS1 is unmatched in value, ease of use and overall performance.

OutBack
Power Systems

Support your local dealers and installers

19009 62nd Avenue NE, Arlington, WA 98223 USA
Telephone: 360-435-6030 Fax: 360-435-6019
www.outbackpower.com





energy independence

For your home, for your business, for your country.



1.3 MWp BP Solar electric system at the U.S. Marine base at 29 Palms, CA

www.bpsolar.com

SUBSCRIBE!

to **HOME POWER** magazine **FAST & EASY** at www.homepower.com
or call 800-707-6585, international 541-512-0201, or fax 541-512-0343

Or, complete and mail this form. Enclose payment as a check, money order, or credit card information.
Tape the form closed carefully or use an envelope so your check won't fall out. Allow up to three weeks for your first issue to arrive.

Shipping Information

Name:

Address:

City:

State:

Zip:

Country:

Phone:

E-mail:

(Never sold or shared.)

(No spam, guaranteed.)

New Subscription

Renewal Subscription

Gift Subscription

Change of Address

Old Zip Code

	USA	Canada*	International*
1 Year: 6 issues Save \$19.20 off the newsstand price!	<input type="checkbox"/> \$22.50 Standard <input type="checkbox"/> \$43.00 1st class	<input type="checkbox"/> \$30.00 Standard <input type="checkbox"/> \$43.00 1st class	<input type="checkbox"/> \$30.00 Ground <input type="checkbox"/> Call for price Air
2 Years: 12 issues Save 10% more!	<input type="checkbox"/> \$40.50 Standard <input type="checkbox"/> \$81.50 1st class	<input type="checkbox"/> \$55.50 Standard <input type="checkbox"/> \$81.50 1st class	<input type="checkbox"/> \$55.50 Ground <input type="checkbox"/> Call for price Air
3 Years: 18 issues Save 15% more!	<input type="checkbox"/> \$57.50 Standard <input type="checkbox"/> \$119.00 1st class	<input type="checkbox"/> \$80.00 Standard <input type="checkbox"/> \$119.00 1st class	<input type="checkbox"/> \$80.00 Ground <input type="checkbox"/> Call for price Air

HP 106

* Canadian and international orders must be in U.S. funds drawn on a U.S. bank.

\$ Subtotal:

Specials add price to subscription above

Quick Start With your subscription above, get our six most recent back issues sent to you right away.

Quick Start + 1 Quick Start above, **PLUS** our Solar1—Renewable Energy Basics on CD-ROM sent right away.

First Year + CD First-time subscribers only: Subscription, **PLUS** any selection from our CD-ROM library.

Enter number of the Solar CD-ROM to add to special. 1 through 9 currently available.

	USA	Canada*	International*
<input type="checkbox"/> Add \$27.50 to your subtotal above	<input type="checkbox"/> Add \$35.00 to your subtotal above	<input type="checkbox"/> Add \$37.00 to your subtotal above	
<input type="checkbox"/> Add \$46.50 to your subtotal above	<input type="checkbox"/> Add \$54.00 to your subtotal above	<input type="checkbox"/> Add \$56.00 to your subtotal above	
<input type="checkbox"/> Add \$21.00 to your subtotal above	<input type="checkbox"/> Add \$22.00 to your subtotal above	<input type="checkbox"/> Add \$23.00 to your subtotal above	

\$ Additional:

Subscription cost plus cost of special

\$ Total:

Billing Information if different from above

Name:

Address:

City:

State:

Zip:

Country:

Phone:

E-mail:

(Never sold or shared.)

(No spam, guaranteed.)

Payment Information

Check Enclosed*

Visa

MasterCard

American Express

Discover

Card Number:

Expiration Date:

Signature:

CSC Number:**

\$ Total:

* Make checks or money orders payable to *Home Power* magazine.

**The last 3 or 4 digit number on the signature strip on the back of your card. (On the front of American Express cards.)

Reader Feedback Survey

Your answers to the following optional questions give us important insight into what you'd like from *Home Power* in the months and years to come. We depend on your input to help us deliver the information readers need most. Thanks in advance.

In the past three years, I've browsed/read ___ issues of *Home Power*.

- 1 to 3
- 4 to 10
- 11 or more

In terms of renewable energy, I'd describe myself as:

- Unconvinced, but curious
- Still learning what's what
- Ready to start shopping
- Building on my existing system(s)
- An RE professional and user

I value the following *Home Power* coverage...

None Some Lots

- | | | | |
|--|--------------------------|--------------------------|--------------------------|
| Product pricing, comparison, reviews, and selection | <input type="checkbox"/> | <input type="checkbox"/> | <input type="checkbox"/> |
| Detailed instruction on how to do things myself | <input type="checkbox"/> | <input type="checkbox"/> | <input type="checkbox"/> |
| Explanations of how various technologies work | <input type="checkbox"/> | <input type="checkbox"/> | <input type="checkbox"/> |
| Real-world examples of renewable energy systems in use | <input type="checkbox"/> | <input type="checkbox"/> | <input type="checkbox"/> |

I value coverage of the following subjects...

None Some Lots

- | | | | |
|------------------------------|--------------------------|--------------------------|--------------------------|
| Domestic electricity | <input type="checkbox"/> | <input type="checkbox"/> | <input type="checkbox"/> |
| Domestic water heating | <input type="checkbox"/> | <input type="checkbox"/> | <input type="checkbox"/> |
| Home heating & cooling | <input type="checkbox"/> | <input type="checkbox"/> | <input type="checkbox"/> |
| Energy efficiency steps | <input type="checkbox"/> | <input type="checkbox"/> | <input type="checkbox"/> |
| Home design & green building | <input type="checkbox"/> | <input type="checkbox"/> | <input type="checkbox"/> |
| Transportation | <input type="checkbox"/> | <input type="checkbox"/> | <input type="checkbox"/> |

I value the following regular features...

None Some Lots

- | | | | |
|---|--------------------------|--------------------------|--------------------------|
| From Us to You | <input type="checkbox"/> | <input type="checkbox"/> | <input type="checkbox"/> |
| Code Corner, John Wiles | <input type="checkbox"/> | <input type="checkbox"/> | <input type="checkbox"/> |
| Independent Power Providers, Don Loweburg | <input type="checkbox"/> | <input type="checkbox"/> | <input type="checkbox"/> |
| Power Politics, Michael Welch | <input type="checkbox"/> | <input type="checkbox"/> | <input type="checkbox"/> |
| Word Power, Ian Woofenden | <input type="checkbox"/> | <input type="checkbox"/> | <input type="checkbox"/> |
| Home & Heart, Kathleen Jarschke-Schultze | <input type="checkbox"/> | <input type="checkbox"/> | <input type="checkbox"/> |
| Ozonal Notes, Richard Perez | <input type="checkbox"/> | <input type="checkbox"/> | <input type="checkbox"/> |
| "What the Heck?" | <input type="checkbox"/> | <input type="checkbox"/> | <input type="checkbox"/> |
| (Reader) Letters | <input type="checkbox"/> | <input type="checkbox"/> | <input type="checkbox"/> |
| Q&A | <input type="checkbox"/> | <input type="checkbox"/> | <input type="checkbox"/> |
| Happenings | <input type="checkbox"/> | <input type="checkbox"/> | <input type="checkbox"/> |

Comments

Your additional comments about *Home Power* past, present, and future...

It's okay to print my comments as a letter to *Home Power*.

Fold Here

Return Address:



NO POSTAGE
NECESSARY
IF MAILED
IN THE
UNITED STATES



HOME POWER
PO BOX 520
ASHLAND OR 97520-9903

